



1

2



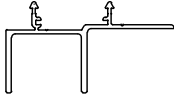
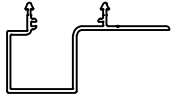
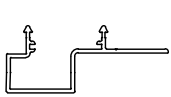

3

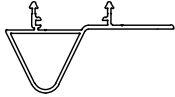
4

Basic profiles

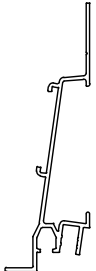
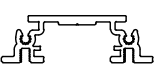
				
EVEN LA.E25.01	BLOCK 25 LA.B25.01	BLOCK 16 LA.B16.01	BLOCK 16L LA.B16L01	CONE LA.CO.01

Support profiles

		
AD.0185	(20x10x2) P0711510	(30x30x3) P6023810
		
LA.S02	(35x35x3) LA.S01	(30x30x3) P6023810

Profiles for door finishing

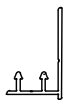
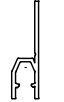
	
LA.D04	LA.D05



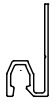
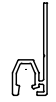
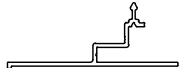

Profiles for window finishing

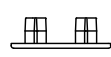
		
EVEN LA.D01	BLOCK LA.D02	LA.D03

Semi-open cladding

	
LA.C01	LA.A03

Standard profiles for window finishing (Testas)

				
LA.L12202 (120x20x2)	LA.L10202 (100x20x2)	LA.L08202 (80x20x2)	LA.L06202 (60x20x2)	LA.L04202 (40x20x2)

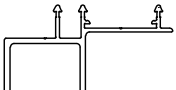
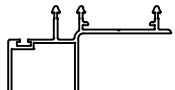
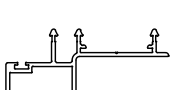
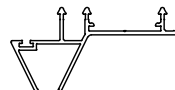

Fitting profiles

			
EVEN LA.E25.05	BLOCK 25 LA.B25.05	BLOCK 16 LA.B16.05	CONE LA.CO.05

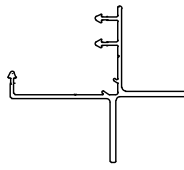
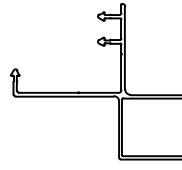
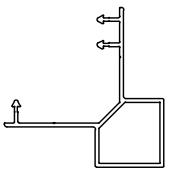
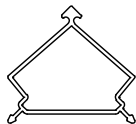
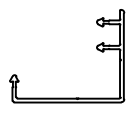
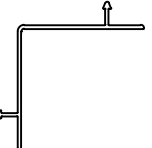

Corner profiles

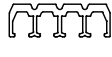
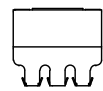
					
EVEN LA.E25.03	BLOCK 25 LA.B25.03	BLOCK 16 LA.B16.03	BLOCK 25 / EVEN LA.A04	CONE LA.CO.03	CONE LA.CO.04

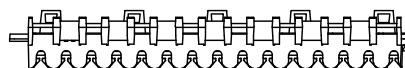
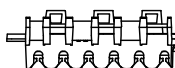
Clips

		
NOMINAL SPACER G0000592	LOWERED CLIPS G0001170	FIRE SAFETY CLIPS G0000830
		
CLIPS G6020944	CLIPS 150 G0000579	CLIPS 60 G0000581

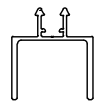
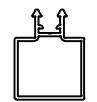
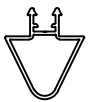
Changing profiles

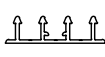
		
EVEN LA.E25.02	BLOCK 25 LA.B25.02	CONE LA.CO.02
		
BLOCK 16 LA.B16.02	LA.A02	



Industriezone "Flanders field"  
8790 Waregem (Belgium)  
Tel. 056/62.71.11 Fax. 056/60.28.51

Drawn By

Date

28/02/2023

Scale  
1:3

PROFILES + CLIPS

Format  
A4

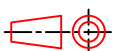

Deze tekening is eigendom van NV RENSON, en mag niet gecopieerd, noch getoond worden aan derden zonder schriftelijke toestemming.

1

2

3

4

A

A

EVEN

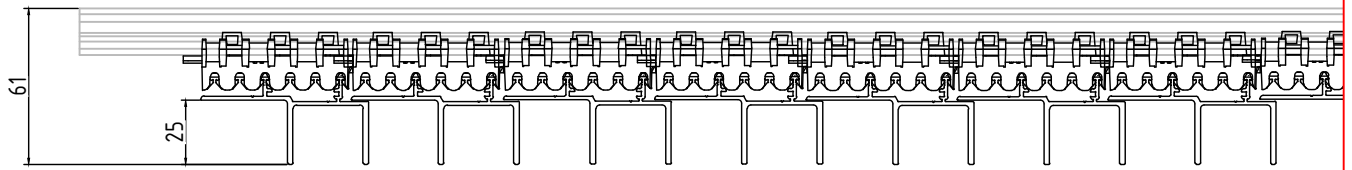

B

B

BLOCK 25

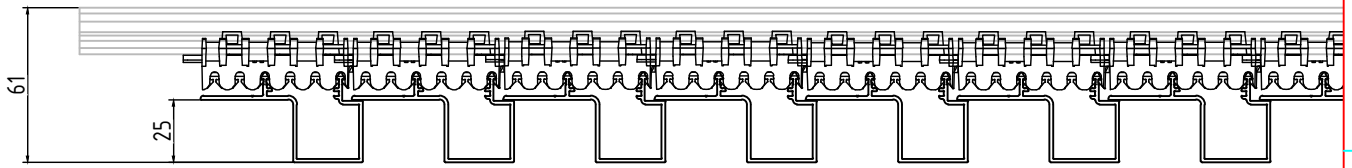

C

C

BLOCK 16/ 16L

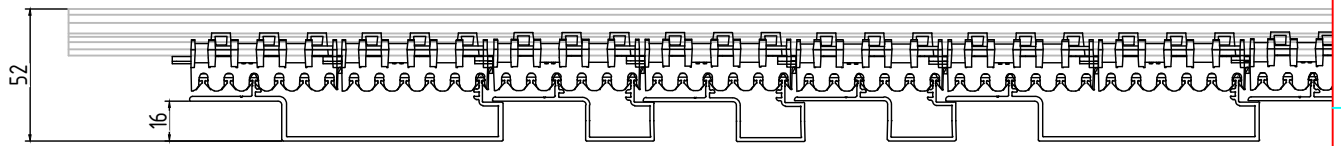

D

D

CONE

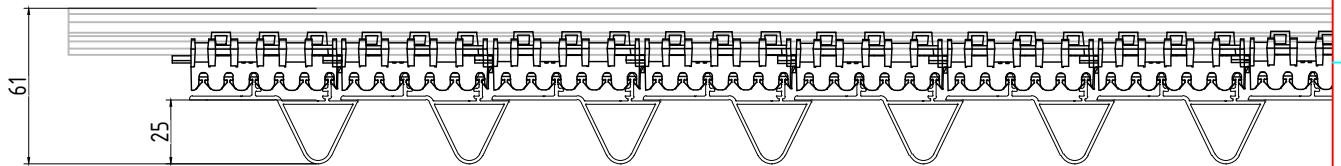

E

E

F

F

Deze tekening is eigendom van NV RENSON, en mag niet gecopieerd, noch getoond worden aan derden zonder schriftelijke toestemming.

Industriezone "Flanders field"  
8790 Waregem (Belgium)  
Tel. 056/62.71.11 Fax. 056/60.28.51

Drawn By		Date 11/05/2020	Scale 1:3
SYSTEM THICKNESS			Format A4

1

2

3

4

Deze tekening is eigendom van NV RENSON, en mag niet gecopieerd, noch getoond worden aan derden zonder schriftelijke toestemming.

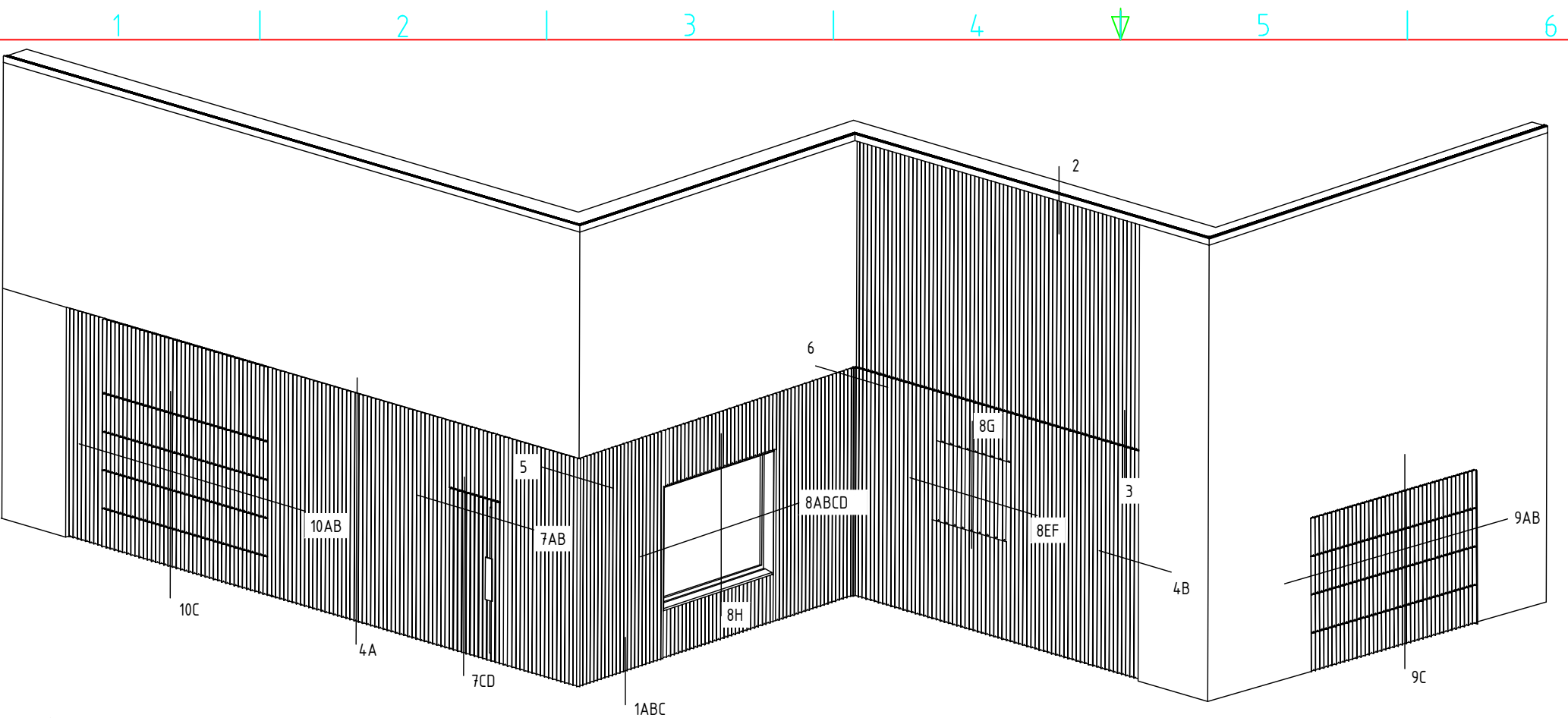

Nr.	Details
1ABC	Bottom wall cladding (with baseboard/with doorstep) - side view
2	Roof edge finish - side view
3	Horizontal joint - side view
4A	Wall connection - side view
4B	Wall connection - top view
5	Outer corner - top view
6	Inner corner - top view
7AB	Cladding on door - top view
7CD	Cladding on door - side view
8AB	Window trim side - top view
8CD	Window in surface facade - top view
8EF	Window trim semi open cladding - top view
8G	Window trim semi open cladding - side view
8H	Window trim topside - side view
9AB	Sectional garage door between other cladding - top view
9C	Sectional garage door between other cladding - side view
10AB	Sectional garage door continuous cladding - top view
10C	Sectional garage door continuous cladding - side view

  
**RENSON**<sup>®</sup>
  
 Creating healthy spaces

Industriezone "Flanders field"  
 8790 Waregem (Belgium)  
 Tel. 056/62.71.11 Fax. 056/60.28.51

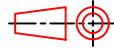
Drawn By		Date	11/05/2020	Scale	1:14
3D OVERVIEW - SECTIONS				Format	A4
					

1 | 2 | 3 | 4 | 5 | 6

1 | 2 | 3 | 4 | 5 | 6

A  
B  
C  
D

1

2

3

4

A

A

B

B

C

C

D









D

E

E

F

F

-  Masonry/cinder block
-  Facade masonry outdoor
-  Wood
-  Unreinforced concrete
-  Thermal insulation
-  Fill insulation
-  Aerated concrete/foam glass
-  Multiplex/fiberboard
-  Plastering/gypsum board

Deze tekening is eigendom van NV RENSON, en mag niet gecopieerd, noch getoond worden aan derden zonder schriftelijke toestemming.

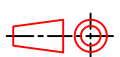
 <b>RENSON</b> <sup>®</sup> Creating healthy spaces Industriezone "Flanders field" 8790 Waregem (Belgium) Tel. 056/62.71.11 Fax. 056/60.28.51	Drawn By		Date 11/05/2020	Scale
	LEGEND			Format A4
				

1

2

3

4

FIXING ON WOOD

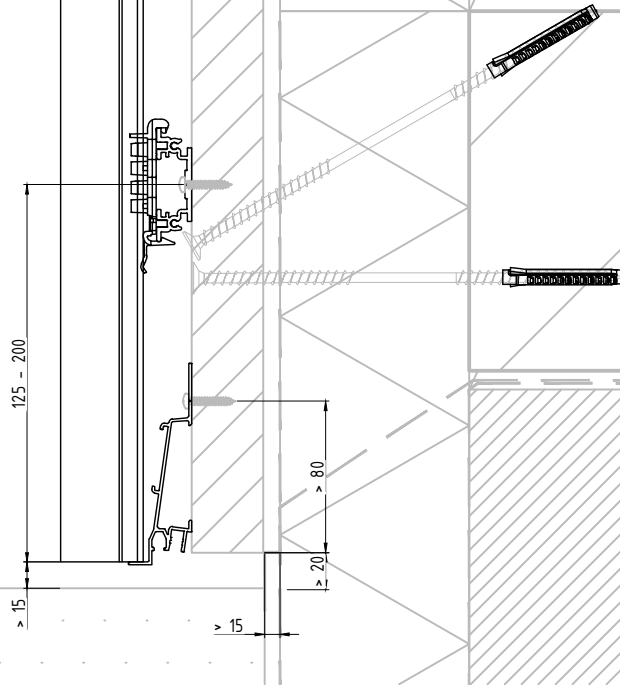

DIRECT FIXING

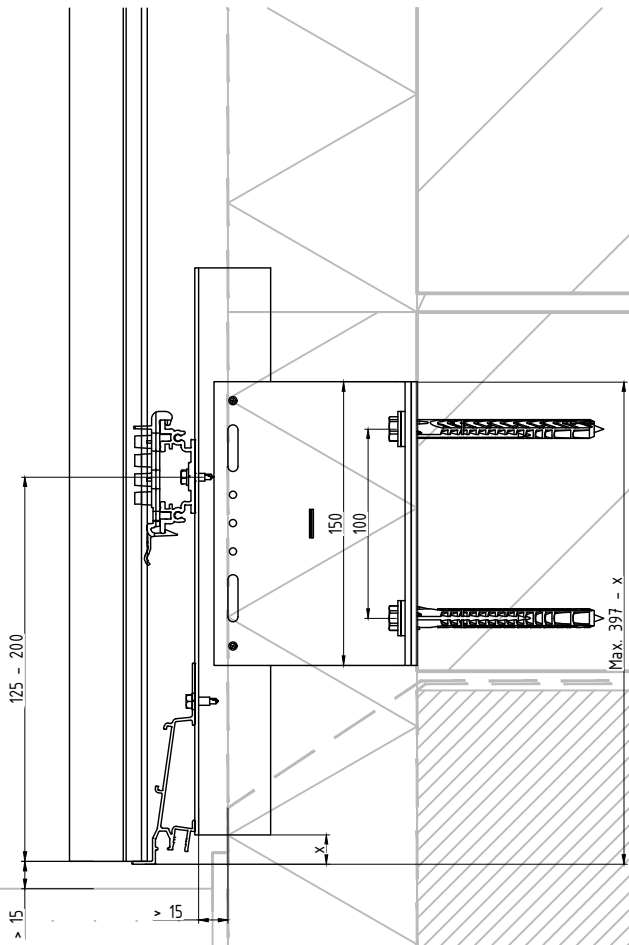

Deze tekening is eigendom van NV RENSON, en mag niet gecopieerd, noch getoond worden aan derden zonder schriftelijke toestemming.

**RENSON**  
Creating healthy spaces

Industriezone "Flanders field"  
8790 Waregem (Belgium)  
Tel. 056/62.71.11 Fax. 056/60.28.51

Drawn By

Date

11/05/2020

Scale

1:4

BOTTOM WALL CLADDING

Format

A4

SIDE VIEW

1A

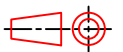

FIXING ON WOOD

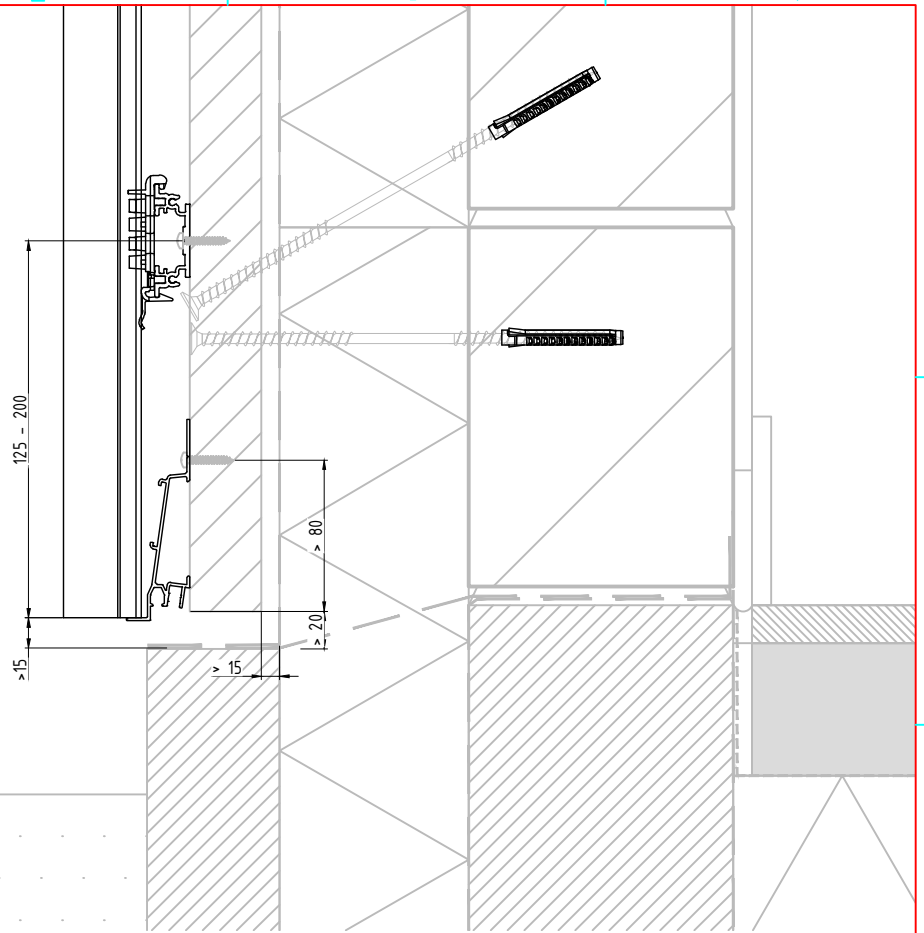

DIRECT FIXING

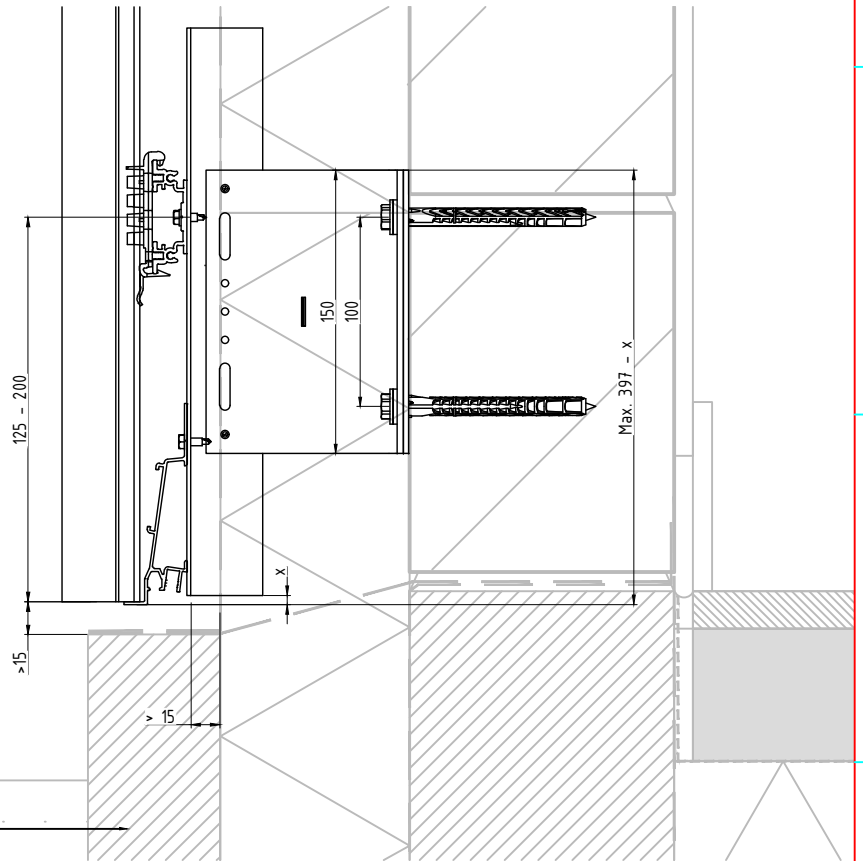

Deze tekening is eigendom van NV RENSON, en mag niet gecopieerd, noch getoond worden aan derden zonder schriftelijke toestemming.

**RENSON**  
Creating healthy spaces

Industriezone "Flanders field"  
8790 Waregem (Belgium)  
Tel. 056/62.71.11 Fax. 056/60.28.51

Drawn By

Date

11/05/2020

Scale  
1:4

BOTTOM WALL CLADDING WITH BASEBOARD

Format  
A4

SIDE VIEW

1B

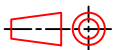

FIXING ON WOOD

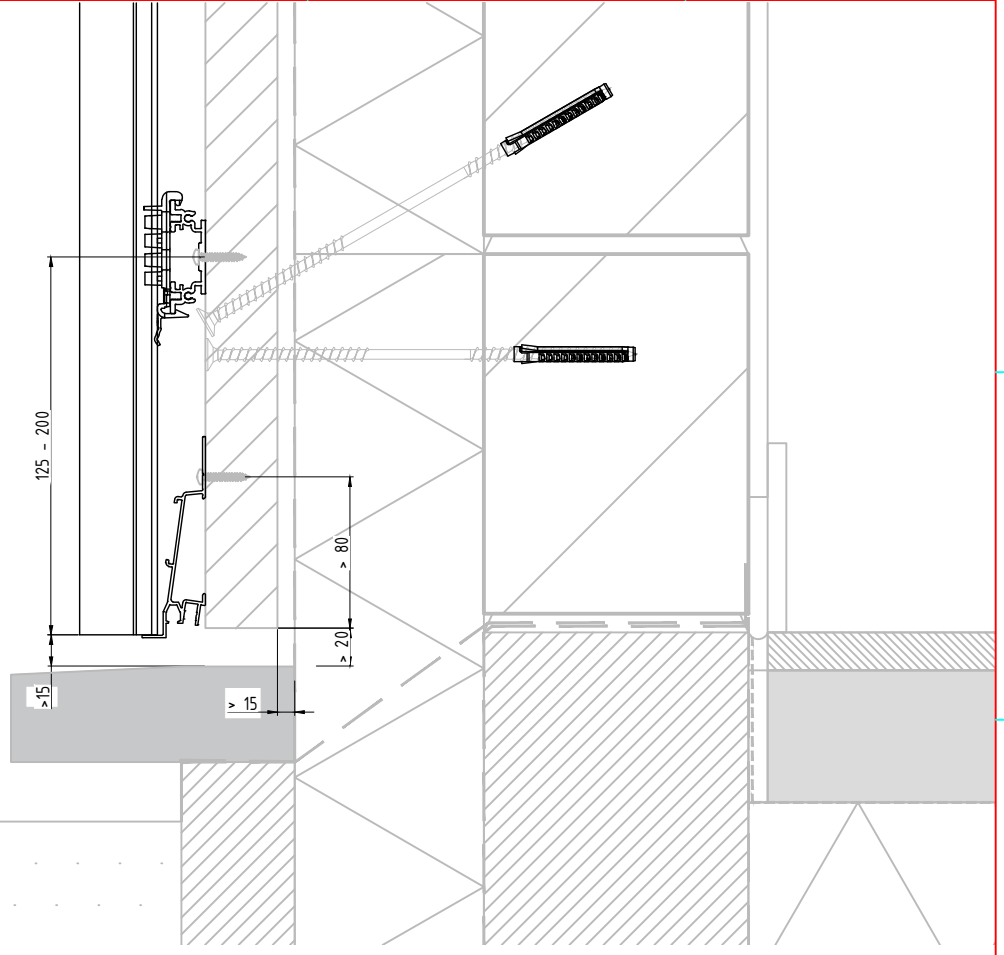

DIRECT FIXING

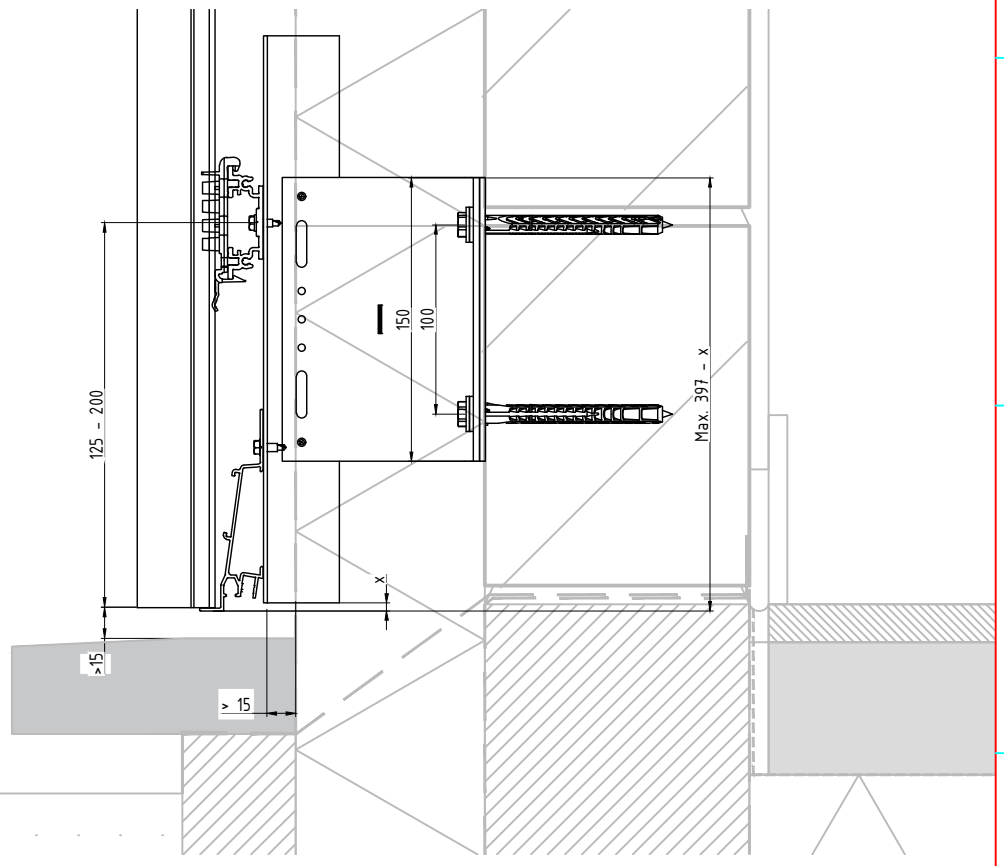

Deze tekening is eigendom van NV RENSON, en mag niet gecopieerd, noch getoond worden aan derden zonder schriftelijke toestemming.

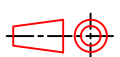
 <b>RENSON</b> <sup>®</sup> Creating healthy spaces Industriezone "Flanders field" 8790 Waregem (Belgium) Tel. 056/62.71.11 Fax. 056/60.28.51	Drawn By	Date 11/05/2020	Scale 1:4
	BOTTOM WALL CLADDING WITH DOORSTEP		Format A4
	SIDE VIEW	1C	

1

2

3

4

FIXING ON WOOD

A

B

C

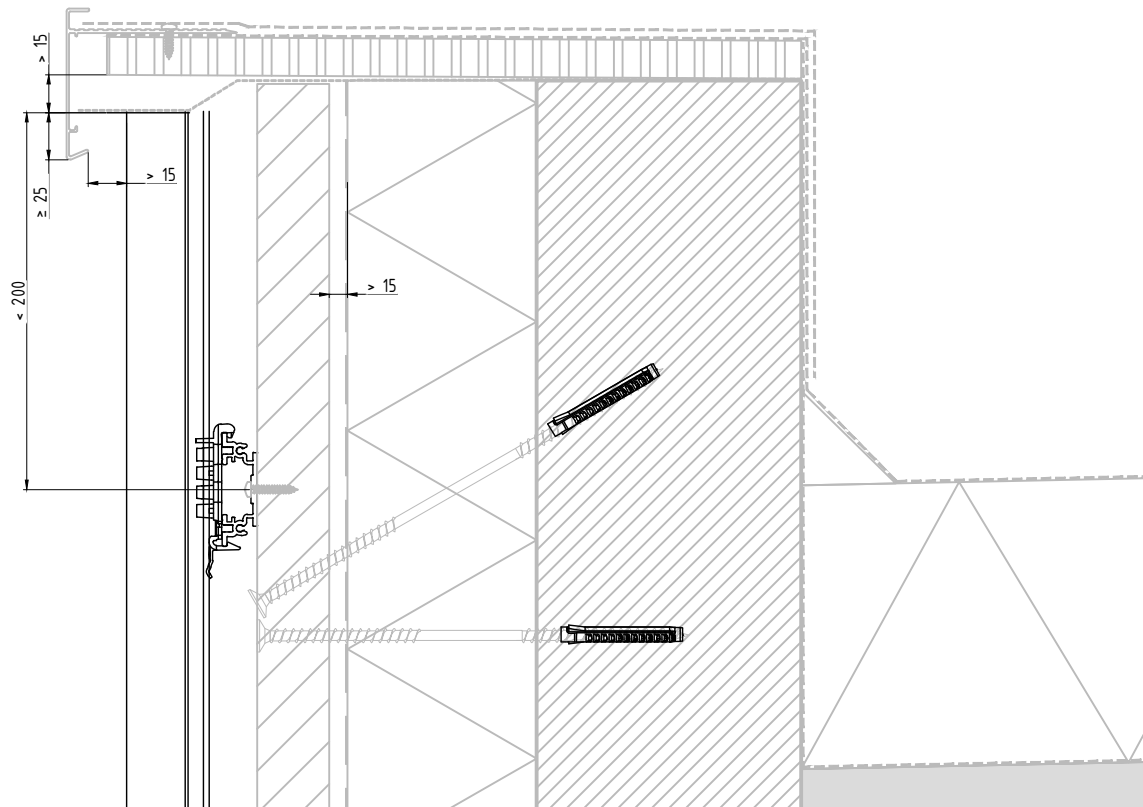

A

B

C

DIRECT FIXING

D

E

F

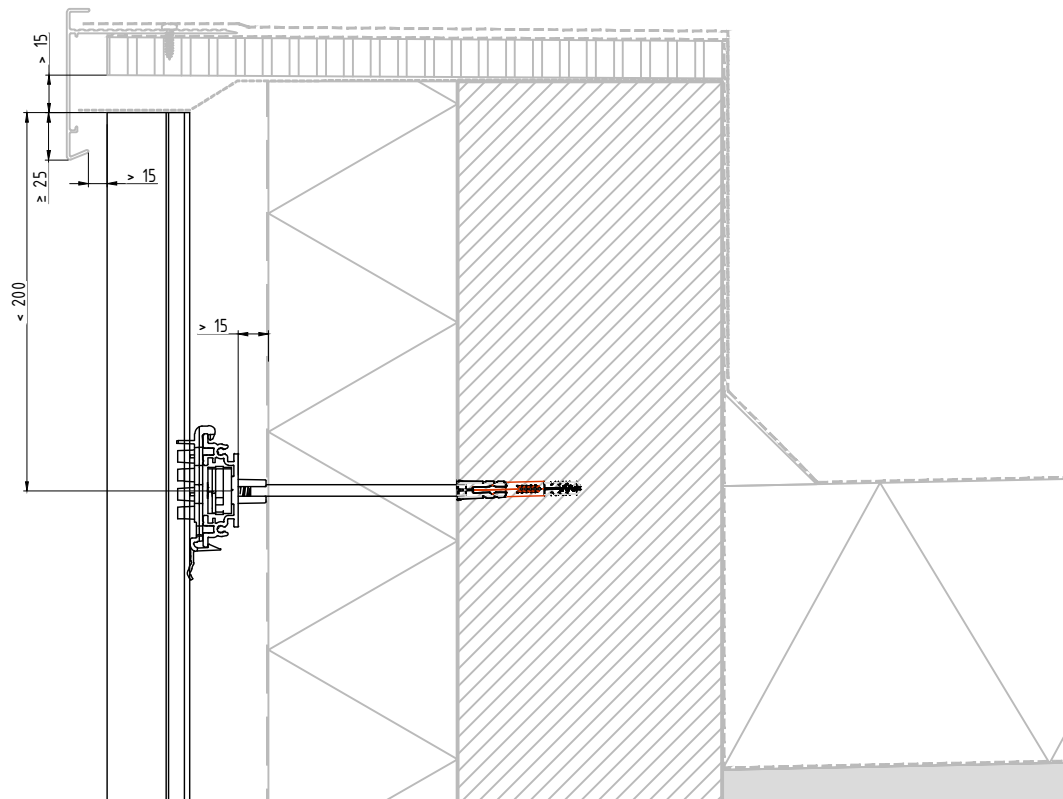

D

E

F

Deze tekening is eigendom van NV RENSON, en mag niet gecopieerd, noch getoond worden aan derden zonder schriftelijke toestemming.

**RENSON**  
 Creating healthy spaces  
 Industriezone "Flanders field"  
 8790 Waregem (Belgium)  
 Tel. 056/62.71.11 Fax. 056/60.28.51

Drawn By

Date  
11/05/2020

Scale  
1:4

ROOF EDGE FINISH

Format  
A4

SIDE VIEW

2

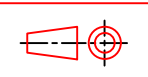

1

2

3

4



FIXING ON WOOD

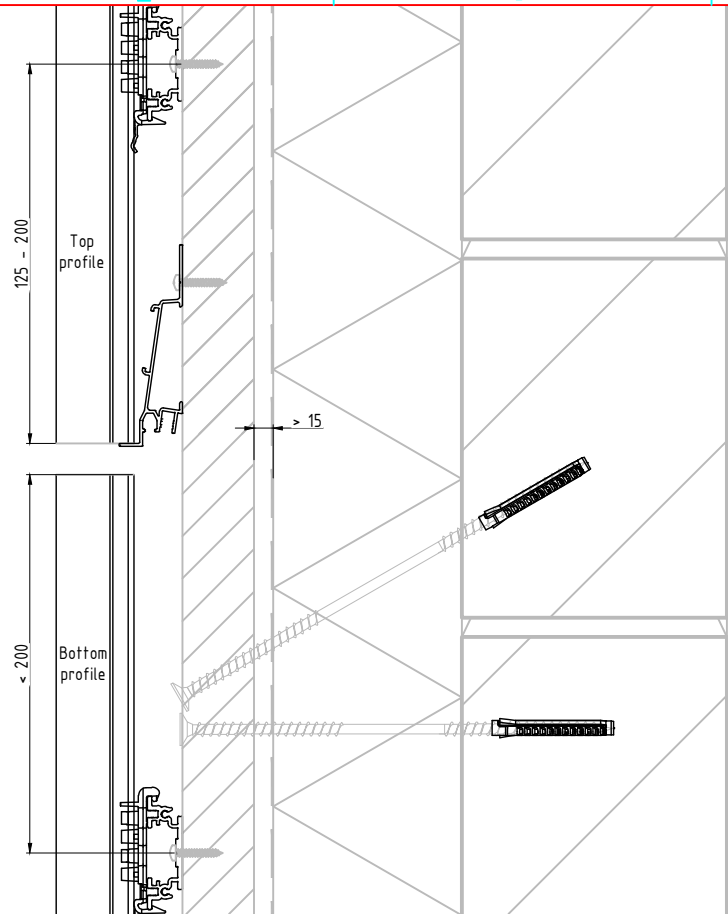

DIRECT FIXING

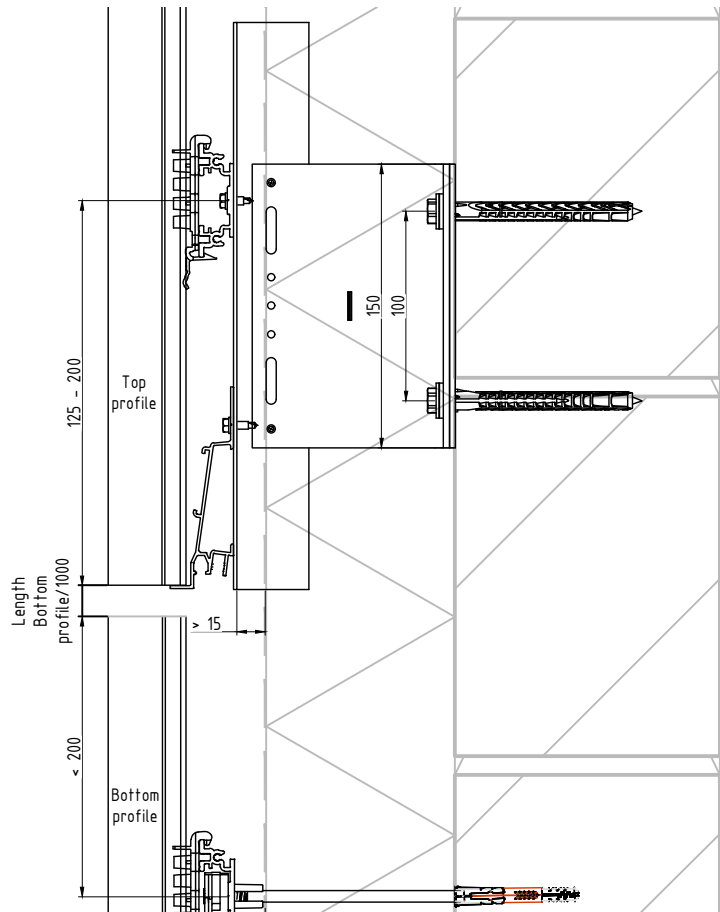

Deze tekening is eigendom van NV RENSON, en mag niet gecopieerd, noch getoond worden aan derden zonder schriftelijke toestemming.

**RENSON**  
Creating healthy spaces

Industriezone "Flanders field"  
8790 Waregem (Belgium)  
Tel. 056/62.71.11 Fax. 056/60.28.51

Drawn By

Date  
11/05/2020

Scale  
1:4

HORIZONTAL JOINT

Format  
A4

SIDE VIEW

3

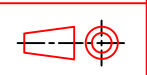

FIXING ON WOOD

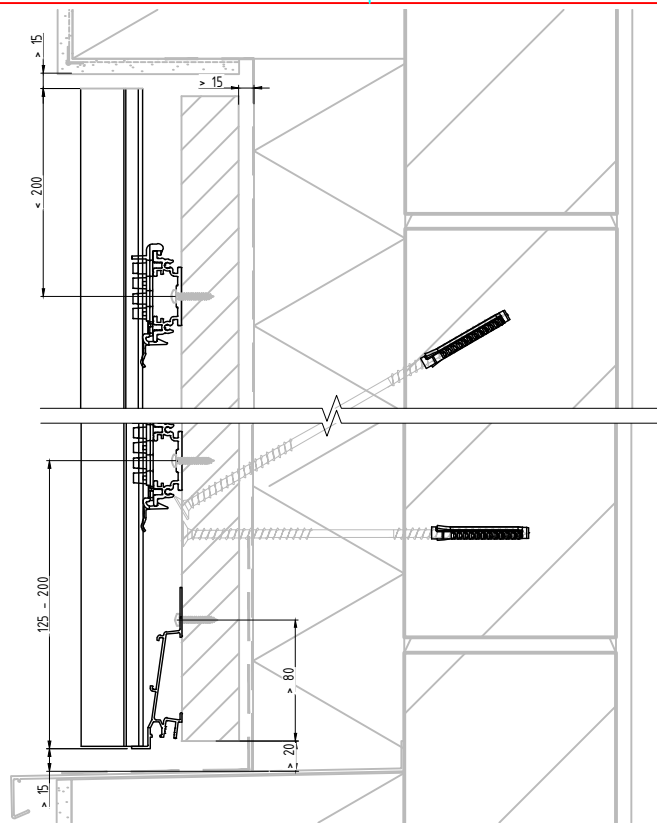

DIRECT FIXING

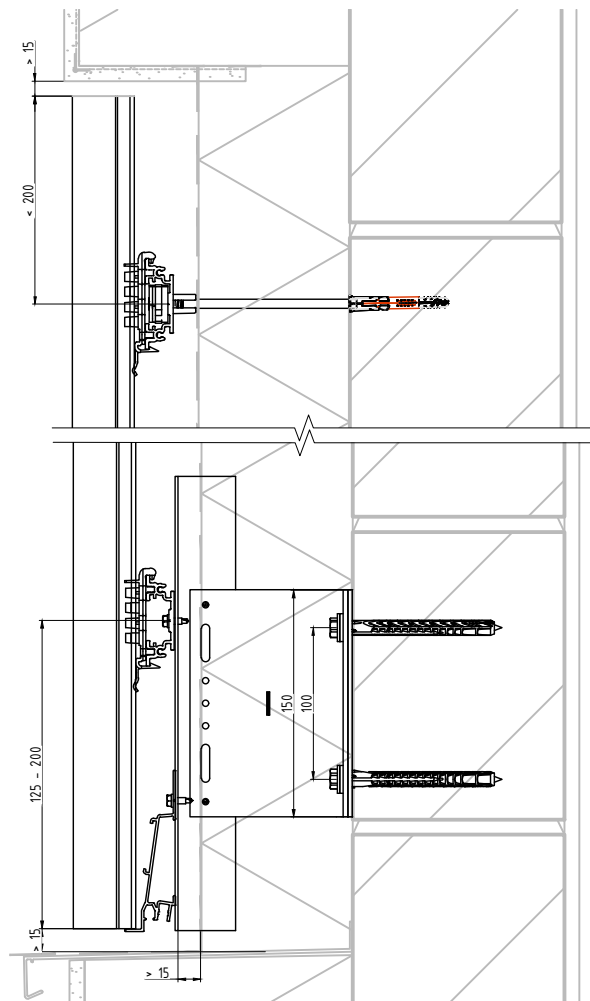

Deze tekening is eigendom van NV RENSON, en mag niet gecopieerd, noch getoond worden aan derden zonder schriftelijke toestemming.

**RENSON**  
Creating healthy spaces

Industriezone "Flanders field"  
8790 Waregem (Belgium)  
Tel. 056/62.71.11 Fax. 056/60.28.51

Drawn By

Date

11/05/2020

Scale  
1:5

WALL CONNECTION (PLASTERING)

Format  
A4

SIDE VIEW

4 A

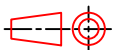

FIXING ON WOOD

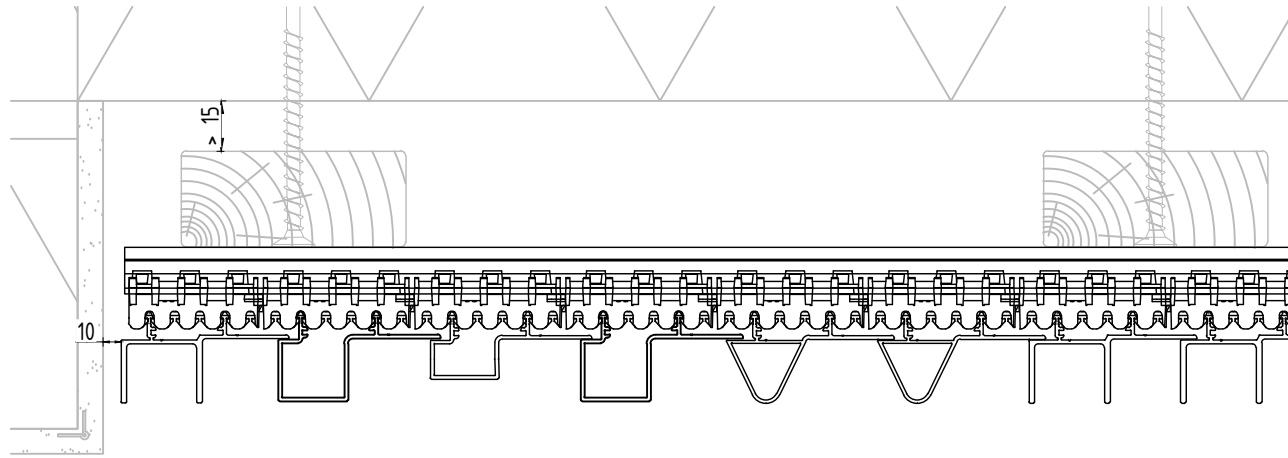

DIRECT FIXING

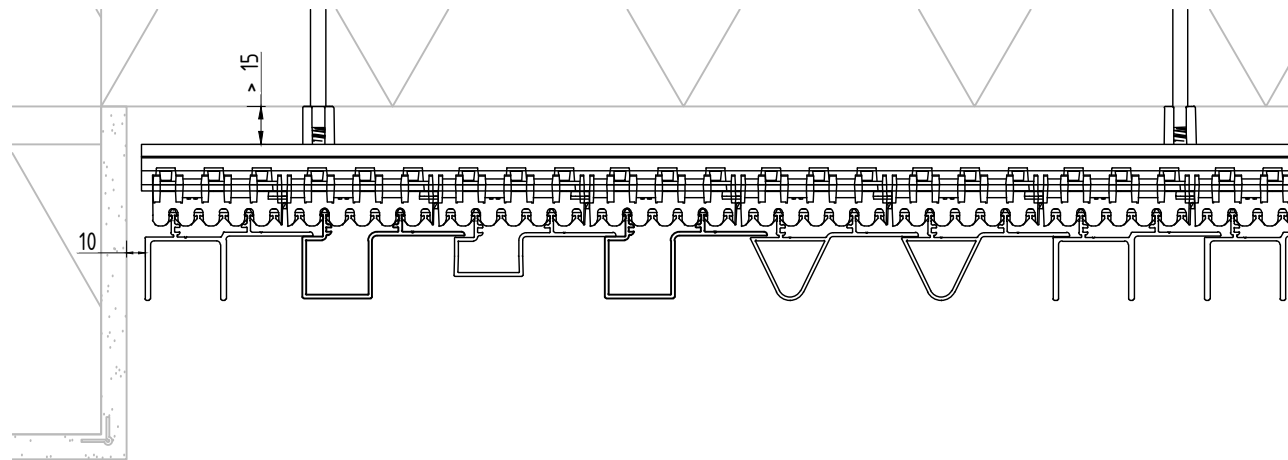

Deze tekening is eigendom van NV RENSON, en mag niet gecopieerd, noch getoond worden aan derden zonder schriftelijke toestemming.

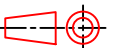

Industriezone "Flanders field"  
8790 Waregem (Belgium)  
Tel. 056/62.71.11 Fax. 056/60.28.51

Drawn By		Date	11/05/2020	Scale	1:3
WALL CONNECTION				Format	
TOP VIEW			4B	A4	
					

1

2

3

4

A

A

B

B

C

C

D

D

E

E

F

F

Deze tekening is eigendom van NV RENSON, en mag niet gecopieerd, noch getoond worden aan derden zonder schriftelijke toestemming.

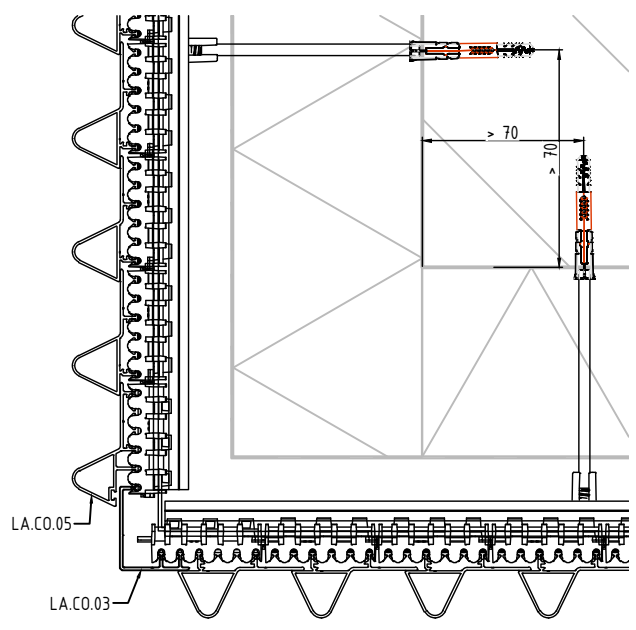
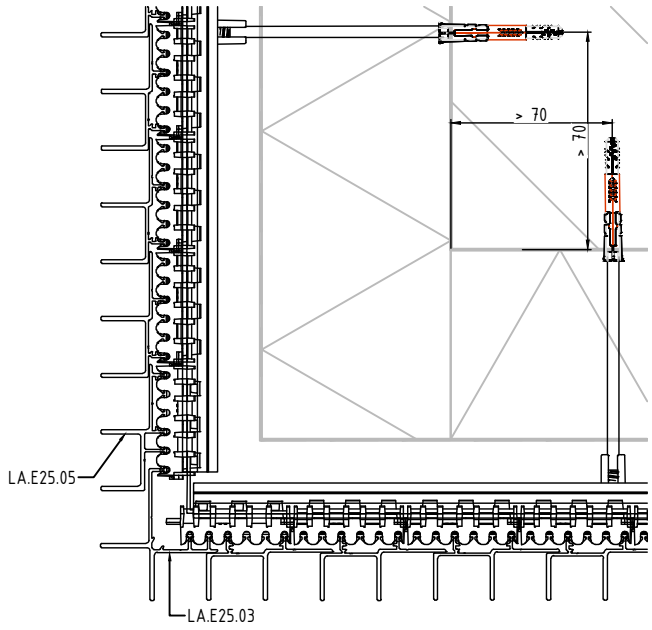
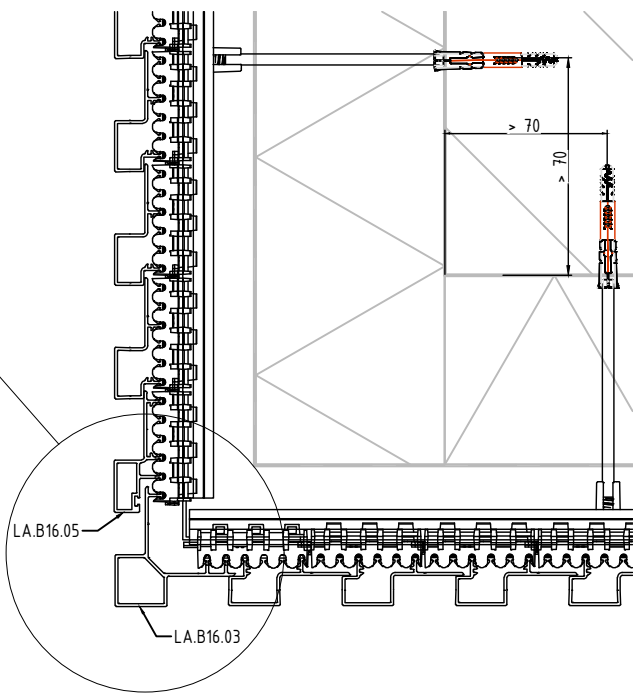
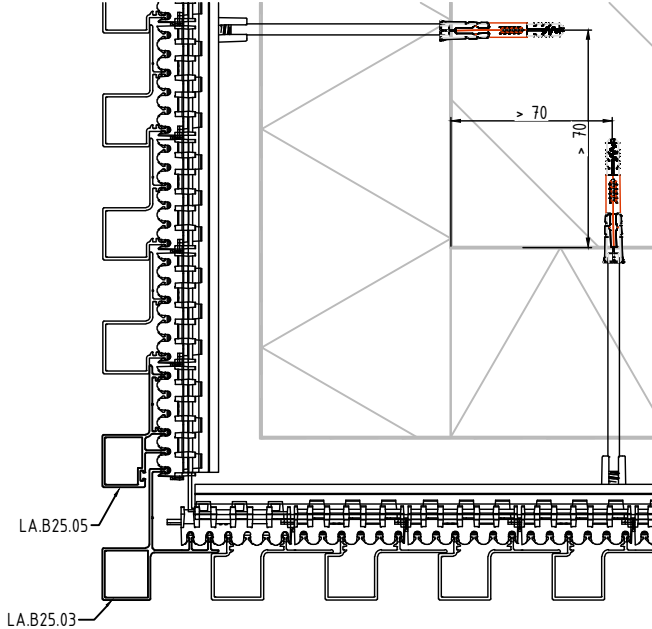
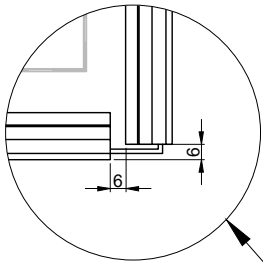

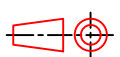
 <p><b>RENSON</b> Creating healthy spaces</p> <p>Industriezone "Flanders field" 8790 Waregem (Belgium) Tel. 056/62.71.11 Fax. 056/60.28.51</p>	Drawn By	Date 11/05/2020	Scale 1:4
	OUTER CORNERS		Format A4
	TOP VIEW	5	

1

2

3

4

A

B

C

D

E

F

A

B

C

D

E

F

Deze tekening is eigendom van NV RENSON, en mag niet gecopieerd, noch getoond worden aan derden zonder schriftelijke toestemming.

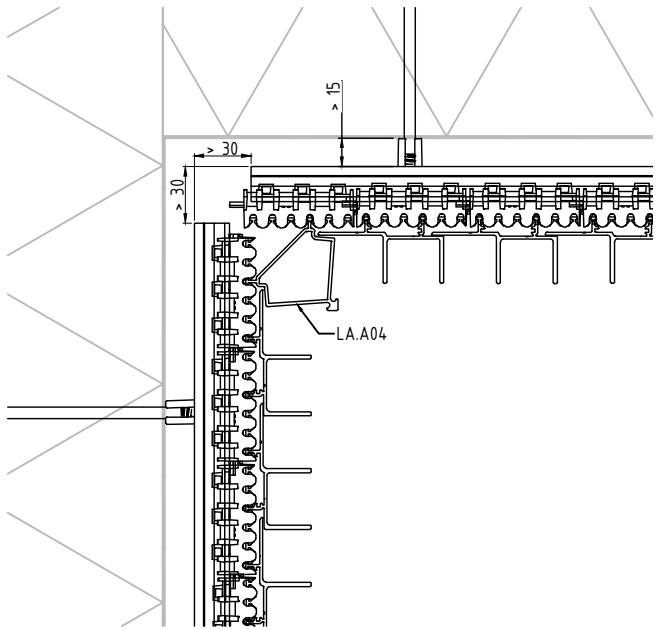
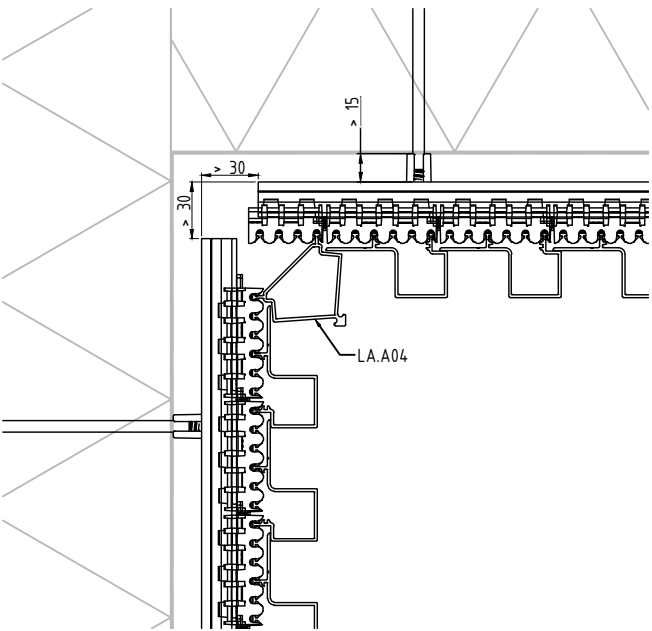
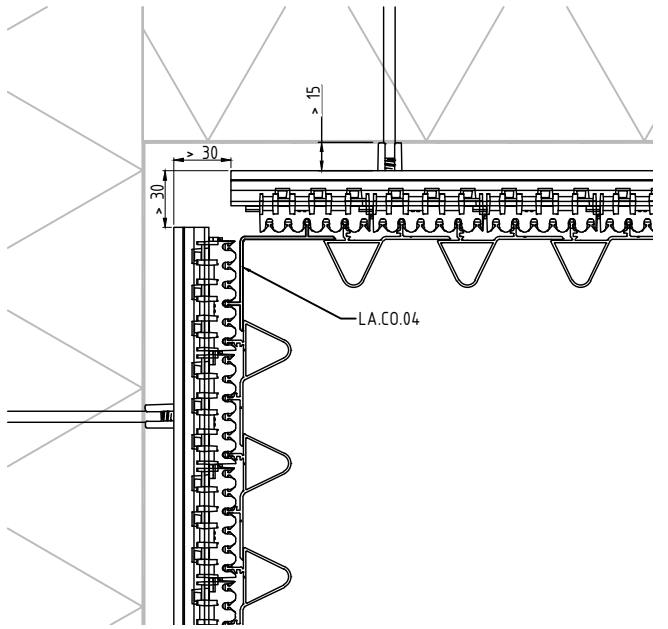
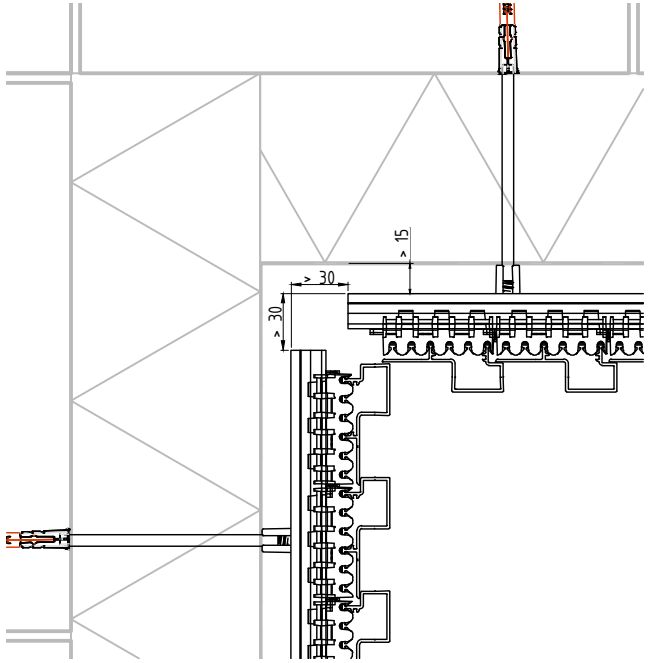

**RENSON**  
Creating healthy spaces

Industriezone "Flanders field"  
8790 Waregem (Belgium)  
Tel. 056/62.71.11 Fax. 056/60.28.51

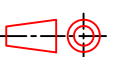
Drawn By	Date 11/05/2020	Scale 1:4
INNER CORNERS		Format A4
TOP VIEW		6 

1

2

3

4

STANDARD SUPPORT PROFILE

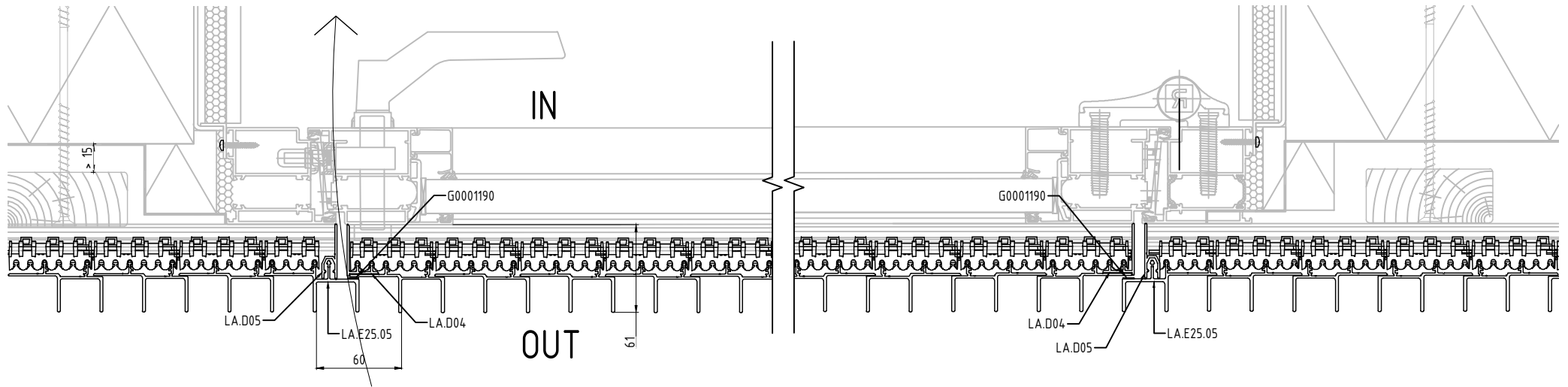

WITH LOWERED CLIPS

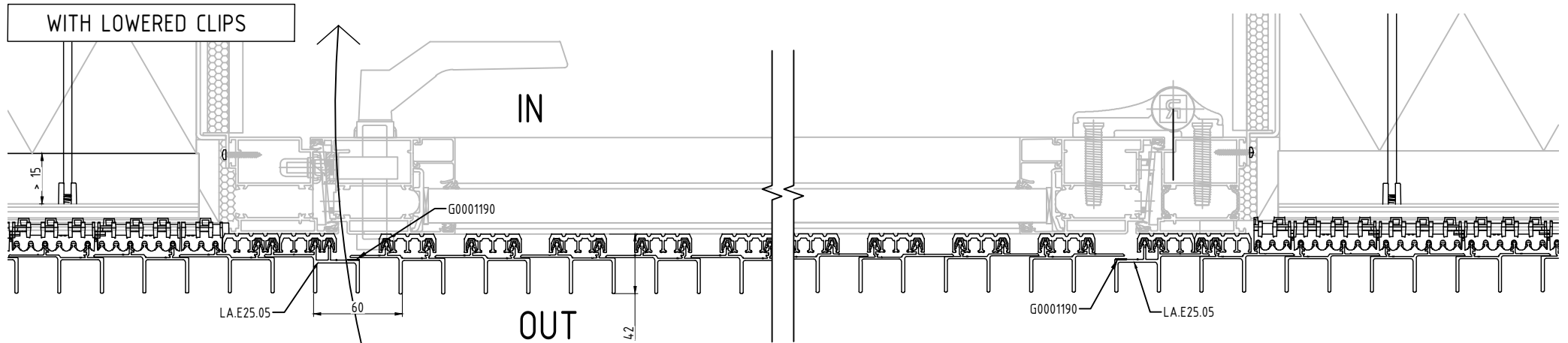

Also applicable on tilting gates

Deze tekening is eigendom van NV RENSON, en mag niet gecopieerd, noch getoond worden aan derden zonder schriftelijke toestemming.



Industriezone "Flanders field"  
8790 Waregem (Belgium)  
Tel. 056/62.71.11 Fax. 056/60.28.51

Drawn By		Date	11/05/2020	Scale	1:4
DOOR CLADDING				Format	
TOP VIEW			7A	A4	

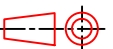

1 | 2 | 3 | 4 | 5 | 6

STANDARD SUPPORT PROFILE

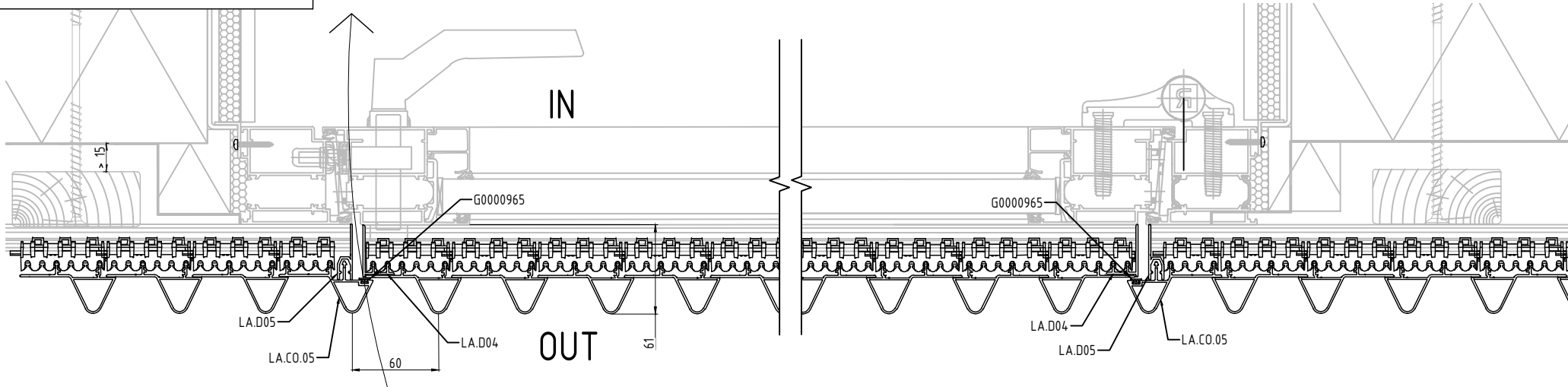

WITH LOWERED CLIPS

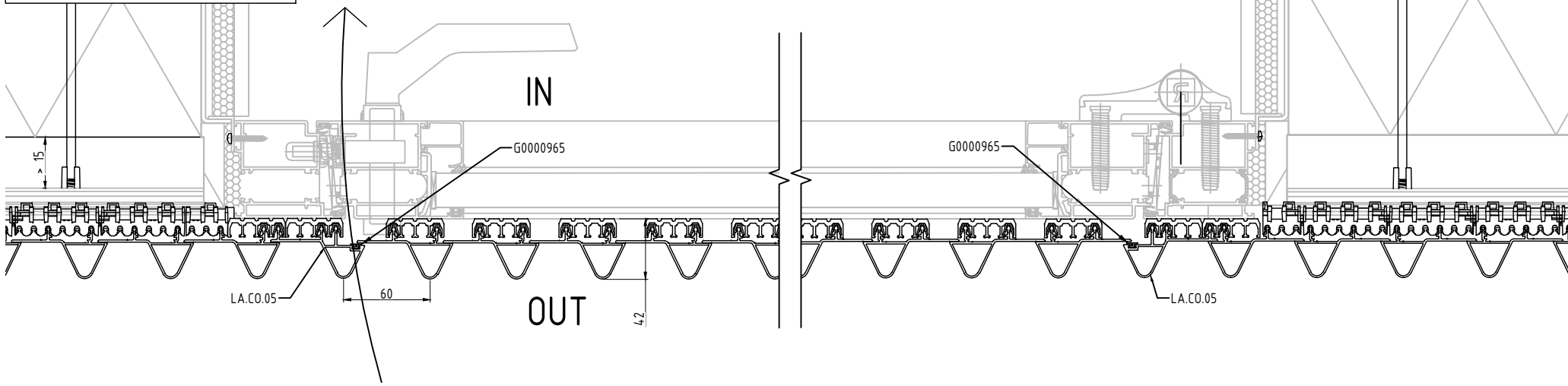

Deze tekening is eigendom van NV RENSON, en mag niet gecopieerd, noch getoond worden aan derden zonder schriftelijke toestemming.

A  
B  
C  
D

A  
B  
C  
D

1 | 2 | 3 | 4 | 5 | 6

<p>Industriezone "Flanders field" 8790 Waregem (Belgium) Tel. 056/62.71.11 Fax. 056/60.28.51</p>	Drawn By	Date 11/05/2020	Scale 1:4
	DOOR CLADDING		Format A4
	TOP VIEW	7B	

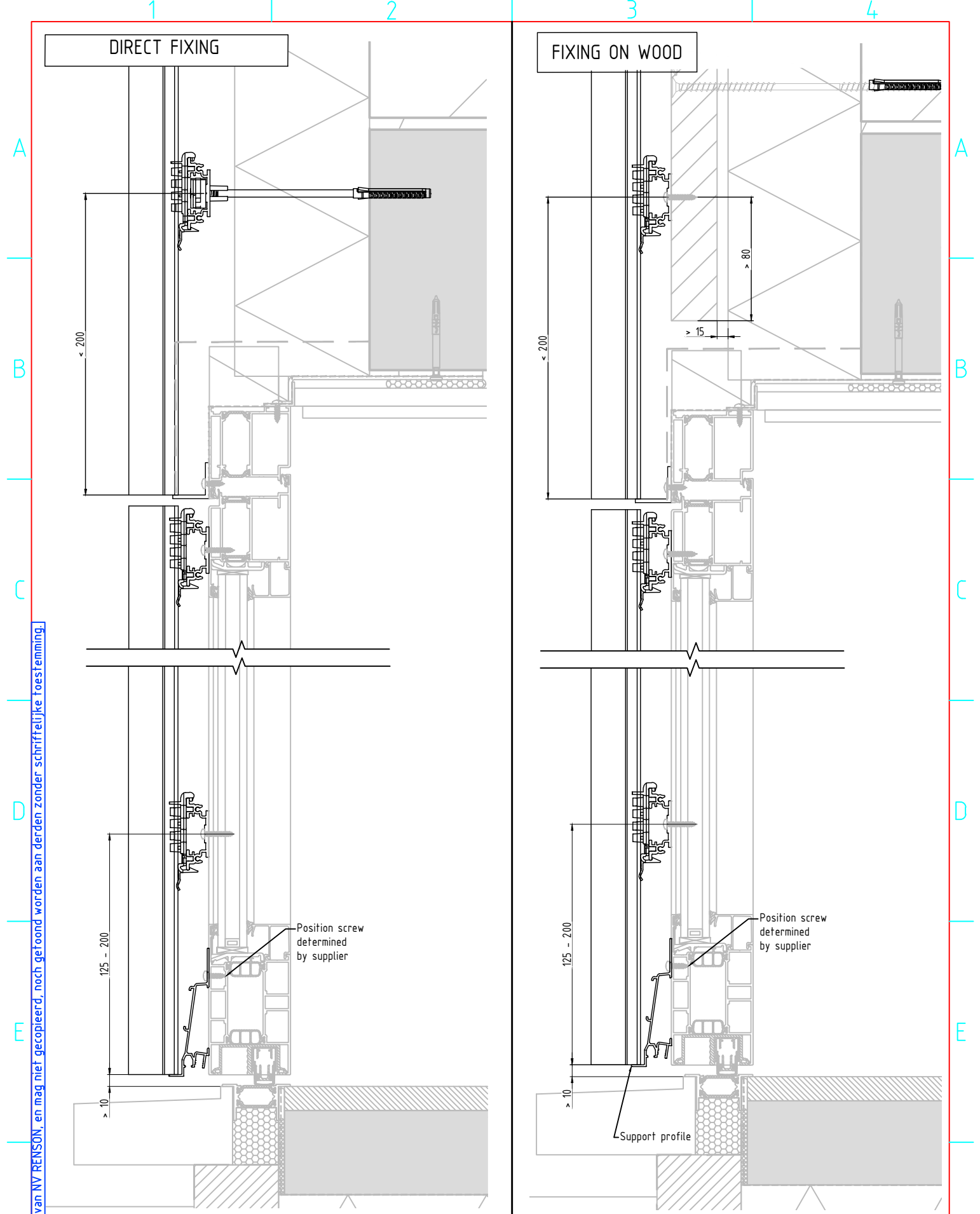

Deze tekening is eigendom van NV RENSON, en mag niet gecopieerd, noch getoond worden aan derden zonder schriftelijke toestemming.

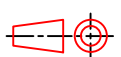
 <b>RENSON</b> <sup>®</sup> Creating healthy spaces Industriezone "Flanders field" 8790 Waregem (Belgium) Tel. 056/62.71.11 Fax. 056/60.28.51	Drawn By	Date	Scale	
	DOOR CLADDING WITH STANDARD SUPPORT PROFILE		11/05/2020	1:4
	SIDE VIEW		7C	Format <b>A4</b> 



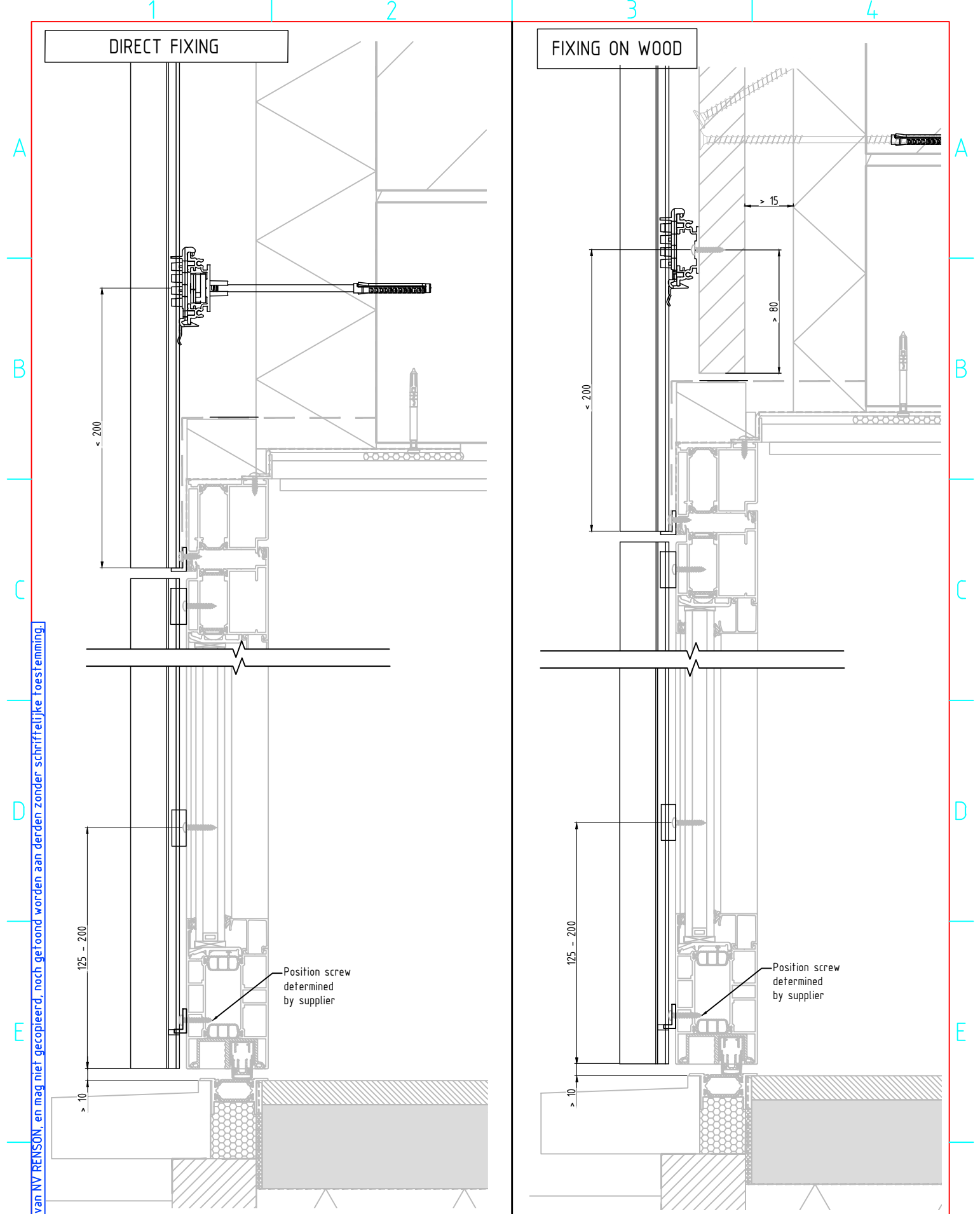

Deze tekening is eigendom van NV RENSON, en mag niet gecopieerd, noch getoond worden aan derden zonder schriftelijke toestemming.

**RENSON**  
 Creating healthy spaces

Industriezone "Flanders field"  
 8790 Waregem (Belgium)  
 Tel. 056/62.71.11 Fax. 056/60.28.51

Drawn By	Date 11/05/2020	Scale 1:4
DOOR CLADDING WITH LOWERED CLIPS		Format A4
SIDE VIEW		7D

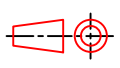

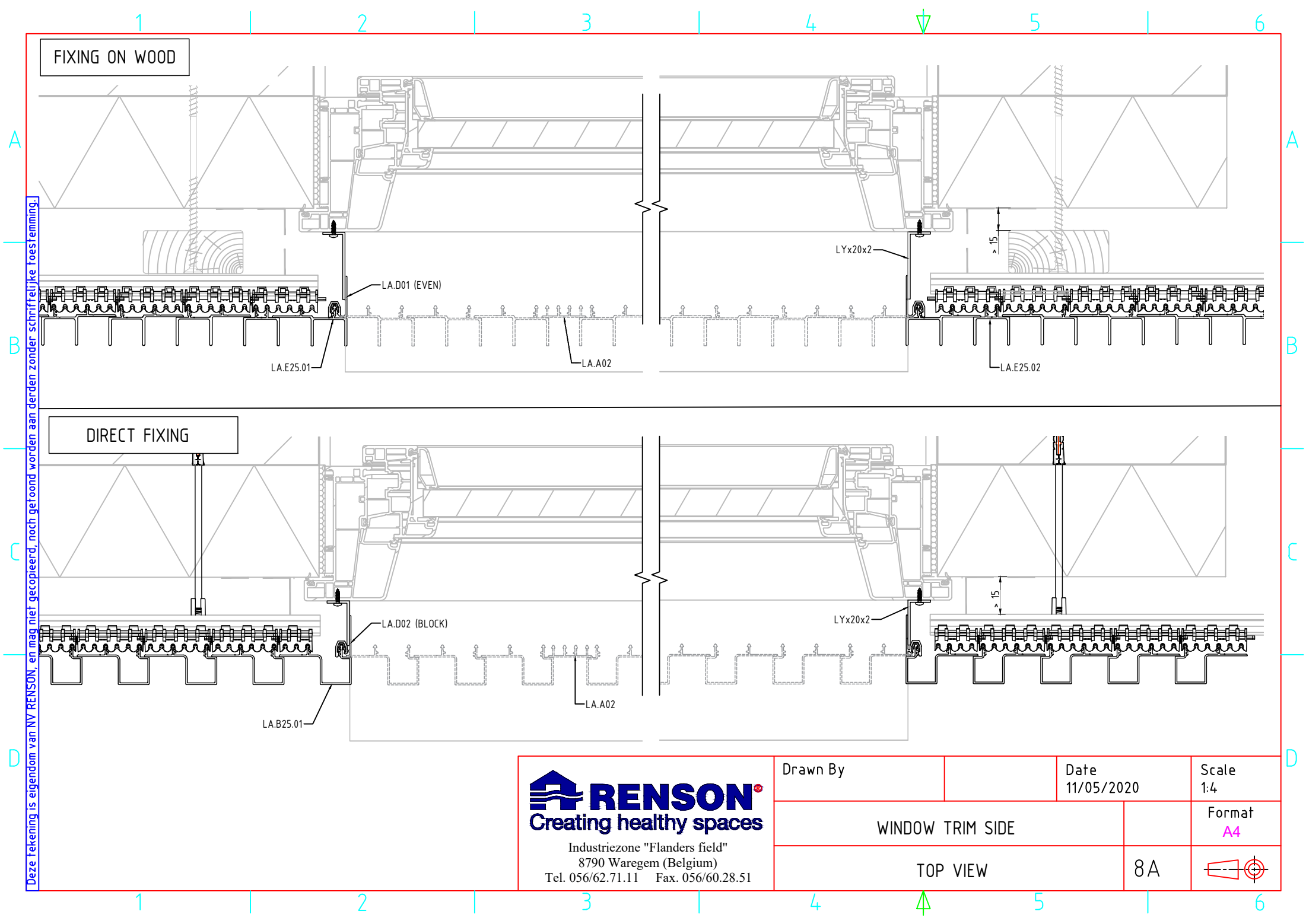

Deze tekening is eigendom van NV RENSON, en mag niet gecopieerd, noch getoond worden aan derden zonder schriftelijke toestemming.

**FIXING ON WOOD**

**DIRECT FIXING**

  
**RENSON®**
  
 Creating healthy spaces

Industriezone "Flanders field"
   
 8790 Waregem (Belgium)
   
 Tel. 056/62.71.11 Fax. 056/60.28.51

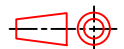
Drawn By		Date	11/05/2020	Scale	1:4
WINDOW TRIM SIDE				Format	
TOP VIEW			8A	A4	
					

FIXING ON WOOD

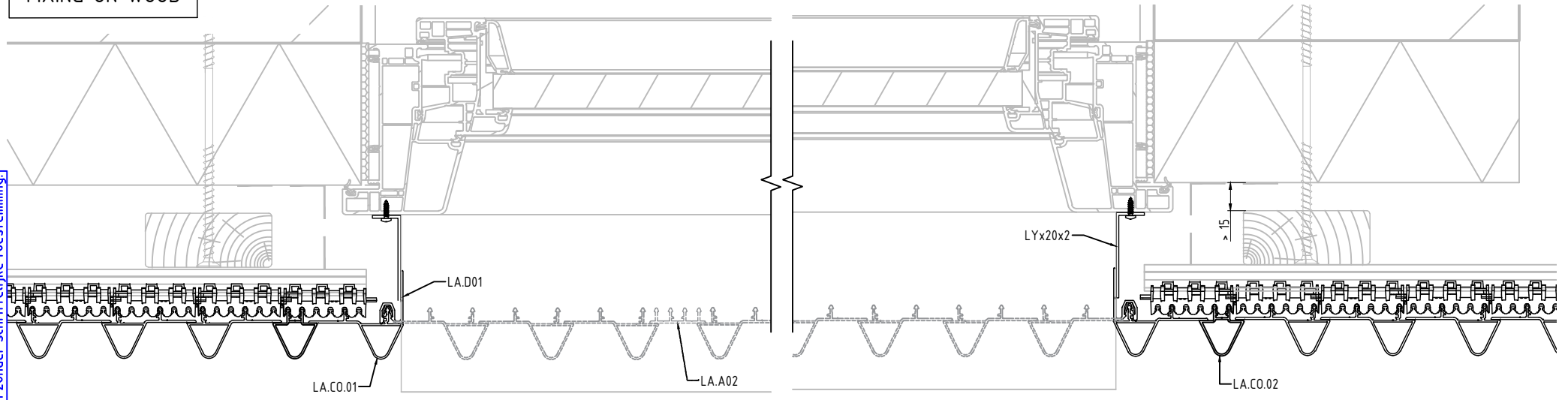

DIRECT FIXING

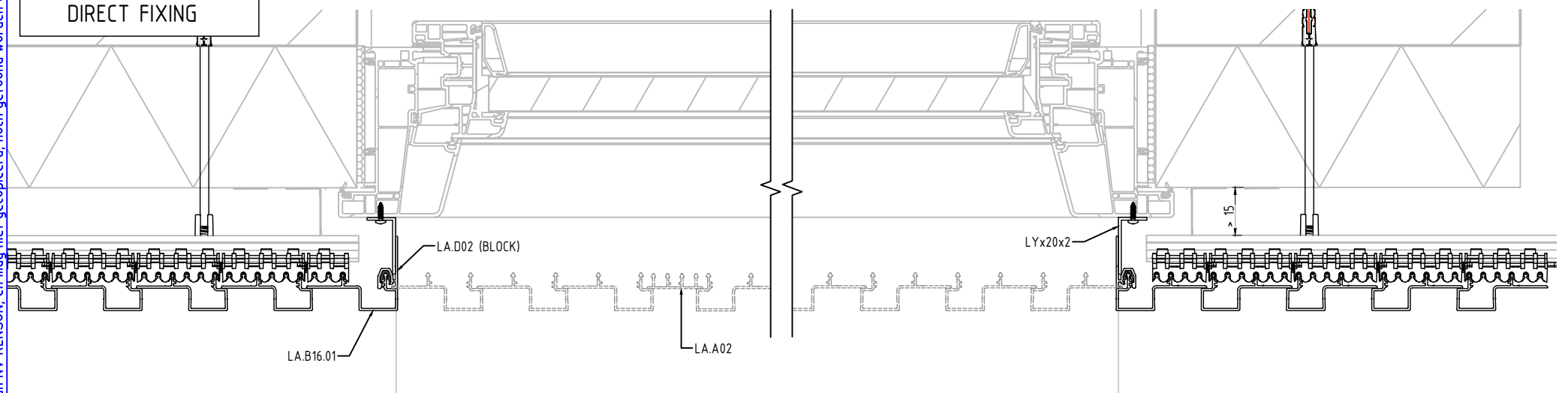

Deze tekening is eigendom van NV RENSON, en mag niet gecopieerd, noch getoond worden aan derden zonder schriftelijke toestemming.

**RENSON**  
 Creating healthy spaces  
 Industriezone "Flanders field"  
 8790 Waregem (Belgium)  
 Tel. 056/62.71.11 Fax. 056/60.28.51

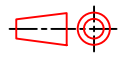
Drawn By	Date 11/05/2020	Scale 1:4
WINDOW TRIM SIDE		Format A4
TOP VIEW		8B 

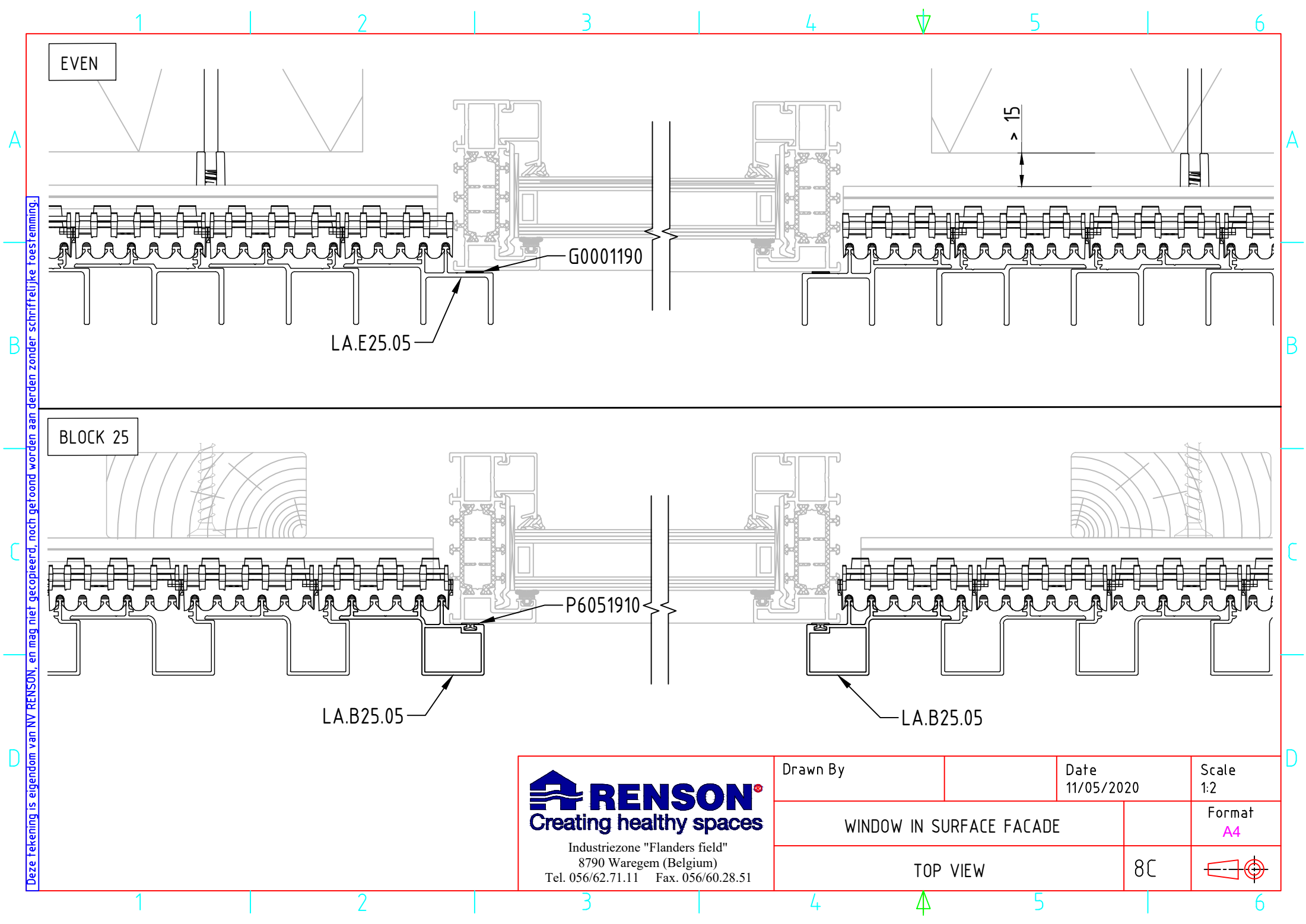

Deze tekening is eigendom van NV RENSON, en mag niet gecopieerd, noch getoond worden aan derden zonder schriftelijke toestemming.

  
**RENSON®**
  
 Creating healthy spaces

Industriezone "Flanders field"
   
 8790 Waregem (Belgium)
   
 Tel. 056/62.71.11 Fax. 056/60.28.51

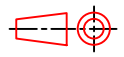
Drawn By		Date	11/05/2020	Scale	1:2
WINDOW IN SURFACE FACADE				Format	A4
TOP VIEW			8C		

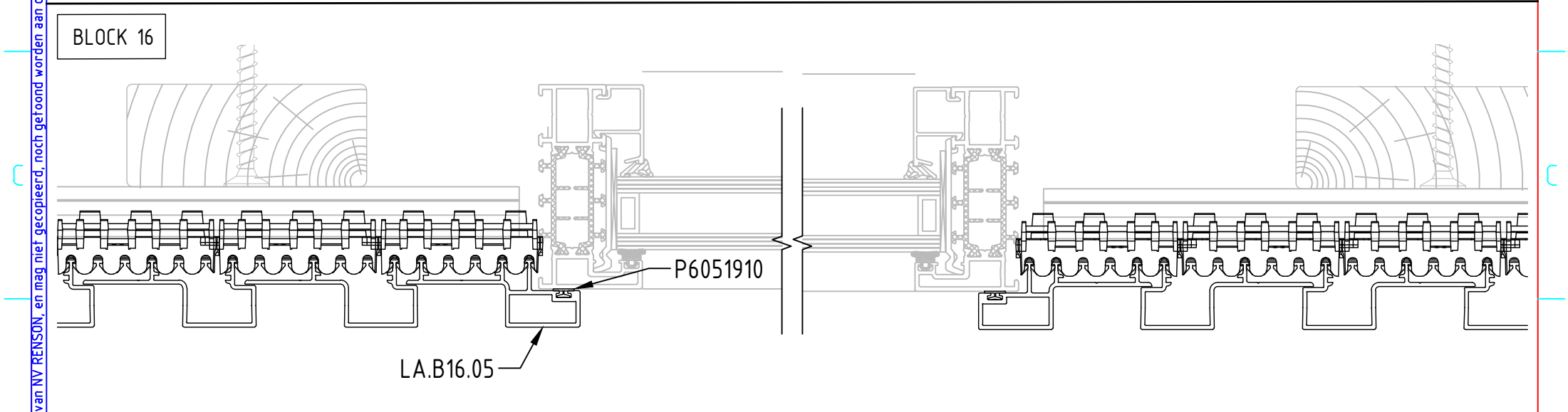
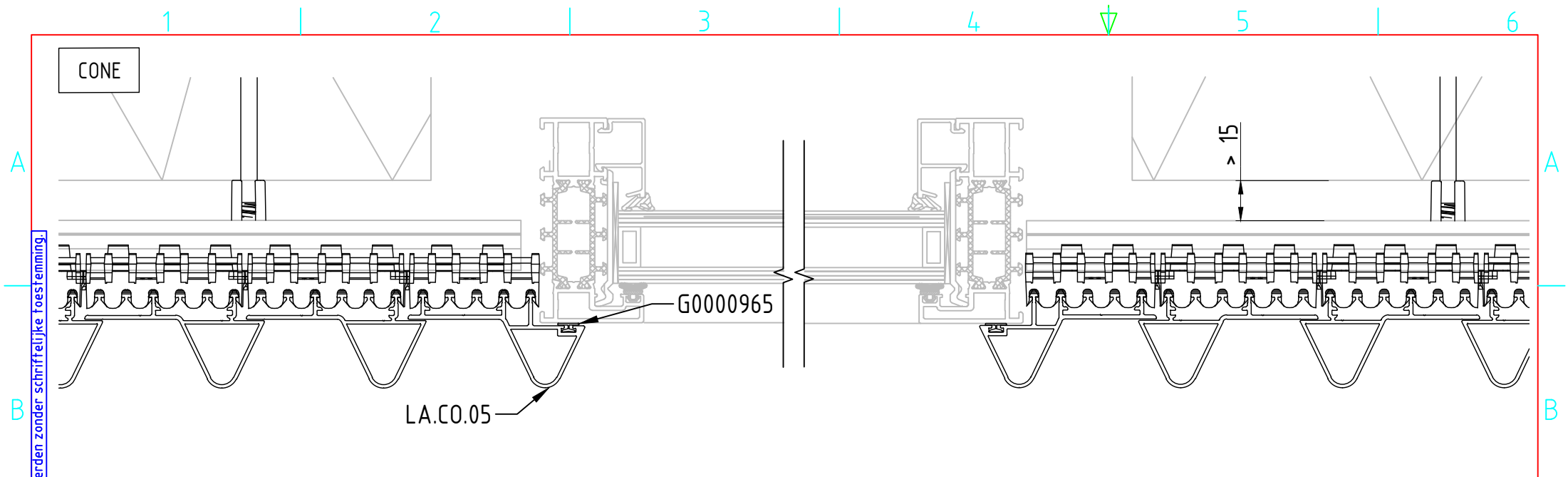

Deze tekening is eigendom van NV RENSON, en mag niet gecopieerd, noch getoond worden aan derden zonder schriftelijke toestemming.

<p>Industriezone "Flanders field" 8790 Waregem (Belgium) Tel. 056/62.71.11 Fax. 056/60.28.51</p>	Drawn By	Date 11/05/2020	Scale 1:2
	WINDOW IN SURFACE FACADE		Format A4
	TOP VIEW	8D	

FIXING ON WOOD

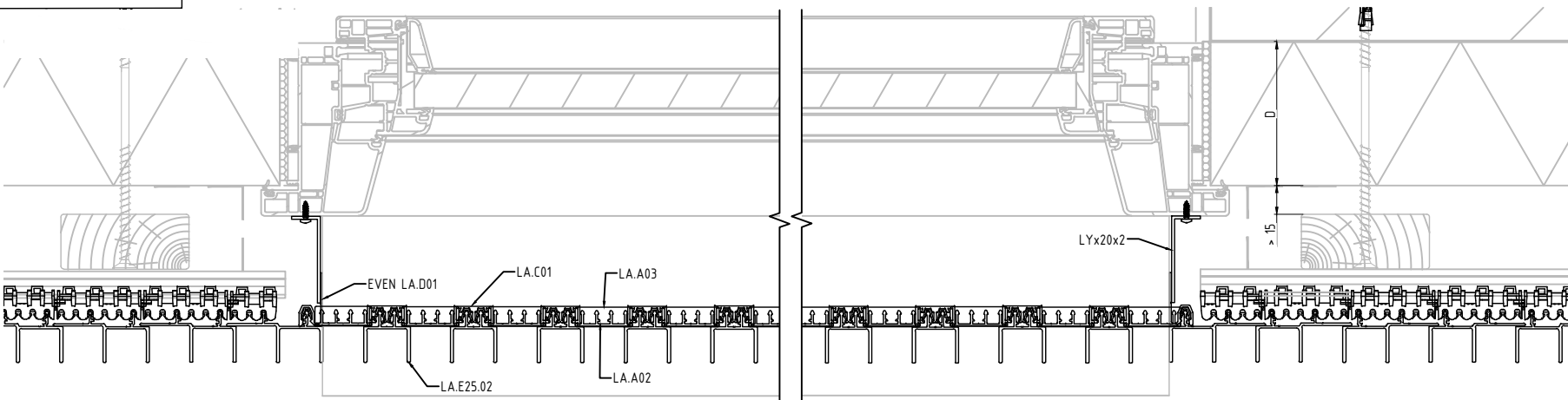

DIRECT FIXING

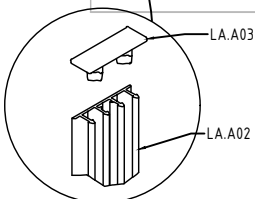
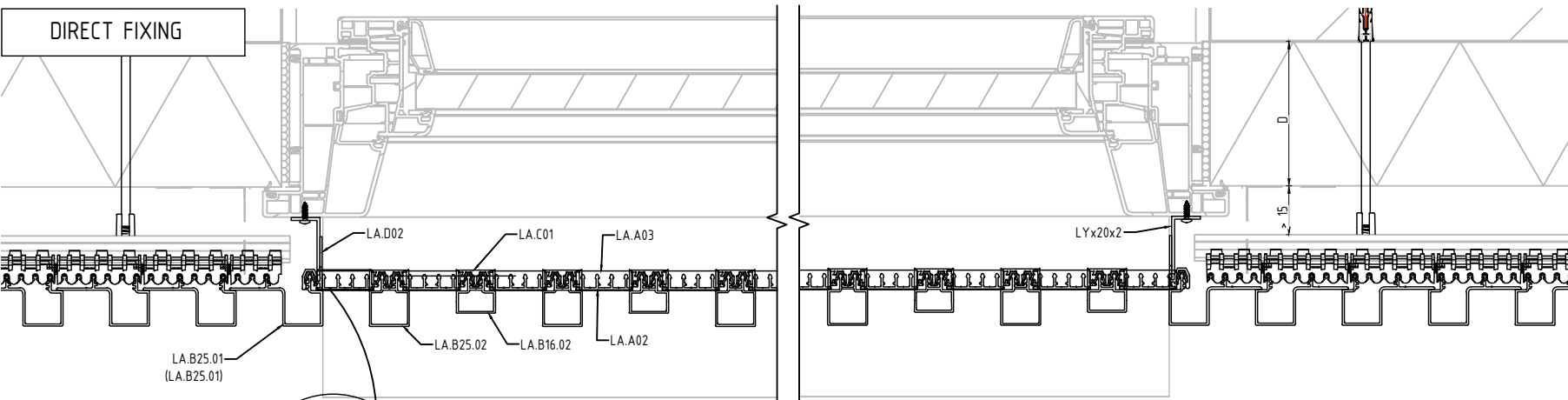

**RENSON**  
Creating healthy spaces

Industriezone "Flanders field"  
8790 Waregem (Belgium)  
Tel. 056/62.71.11 Fax. 056/60.28.51

Drawn By

Date  
11/05/2020

Scale  
1:4

WINDOW TRIM SEMI-OPEN CLADDING

Format  
A4

TOP VIEW

8E



Deze tekening is eigendom van NV RENSON, en mag niet gecopieerd, noch getoond worden aan derden zonder schriftelijke toestemming.



1

2

3

4

DIRECT FIXING

FIXING ON WOOD

A

A

B

B

C

C

D

D

E

E

F

F

Deze tekening is eigendom van NV RENSON, en mag niet gecopieerd, noch getoond worden aan derden zonder schriftelijke toestemming.

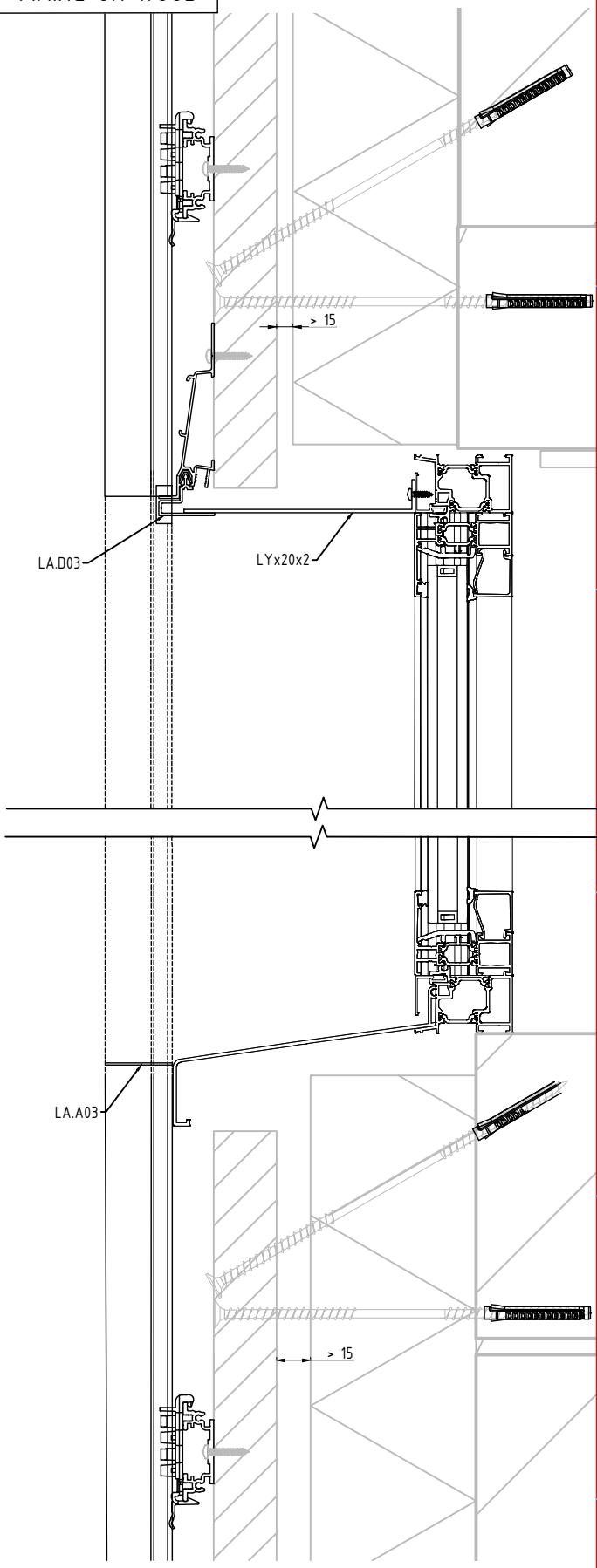
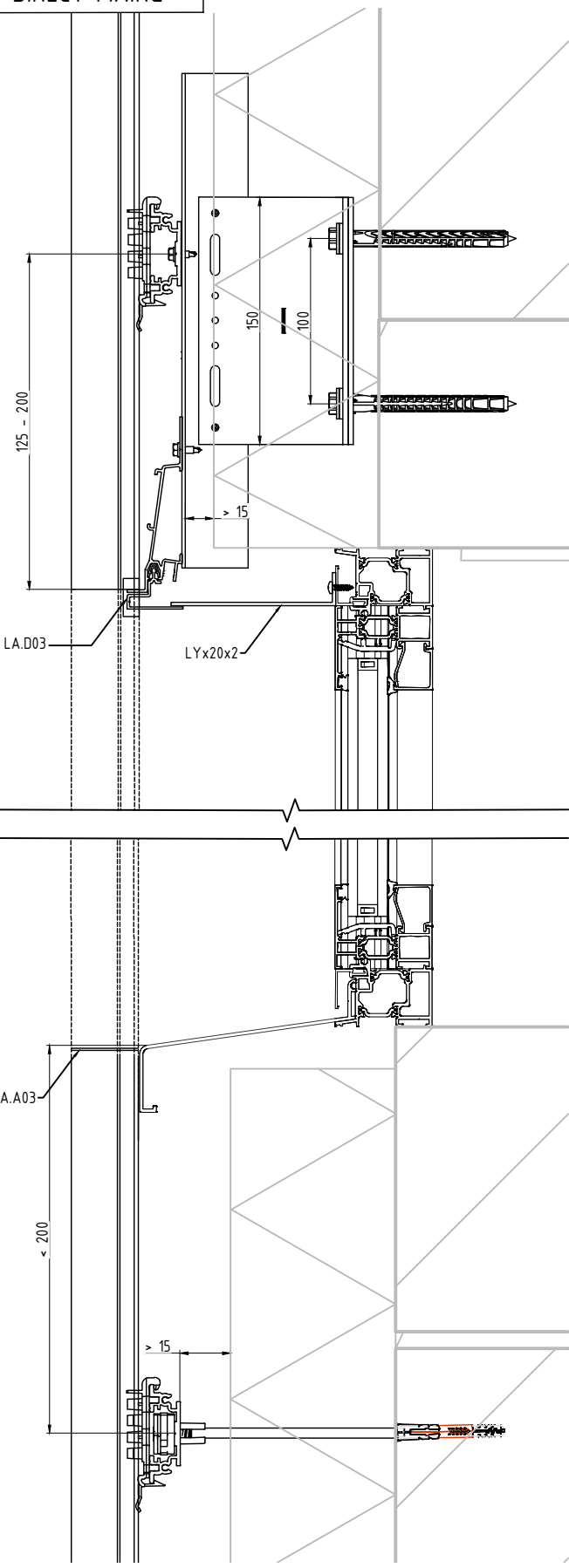

**RENSON**  
Creating healthy spaces

Industriezone "Flanders field"  
8790 Waregem (Belgium)  
Tel. 056/62.71.11 Fax. 056/60.28.51

Drawn By

Date  
11/05/2020

Scale  
1:4

WINDOW TRIM SEMI OPEN CLADDING

Format  
A4

SIDE VIEW

8G

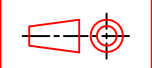

1

2

3

4



1

2

3

4

DIRECT FIXING

FIXING ON WOOD

A

B

C

D

E

F

A

B

C

D

E

F

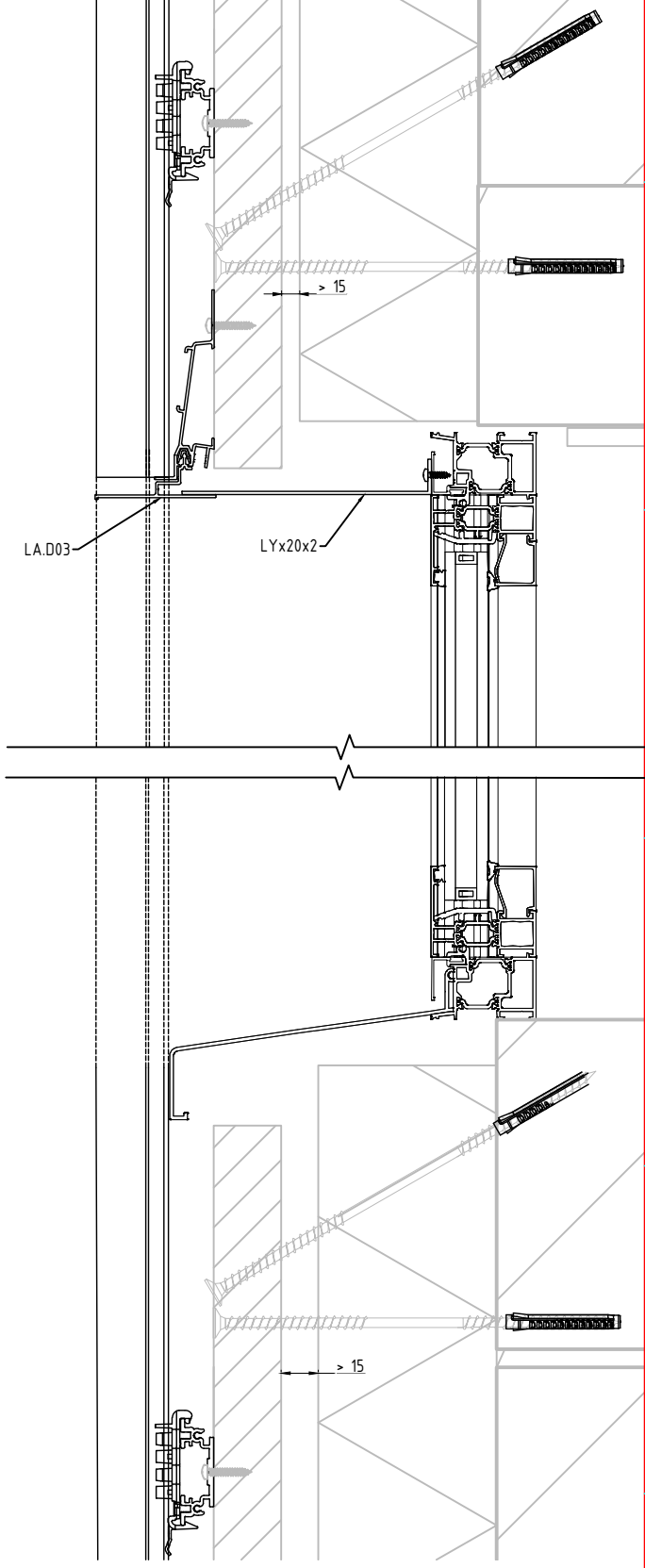
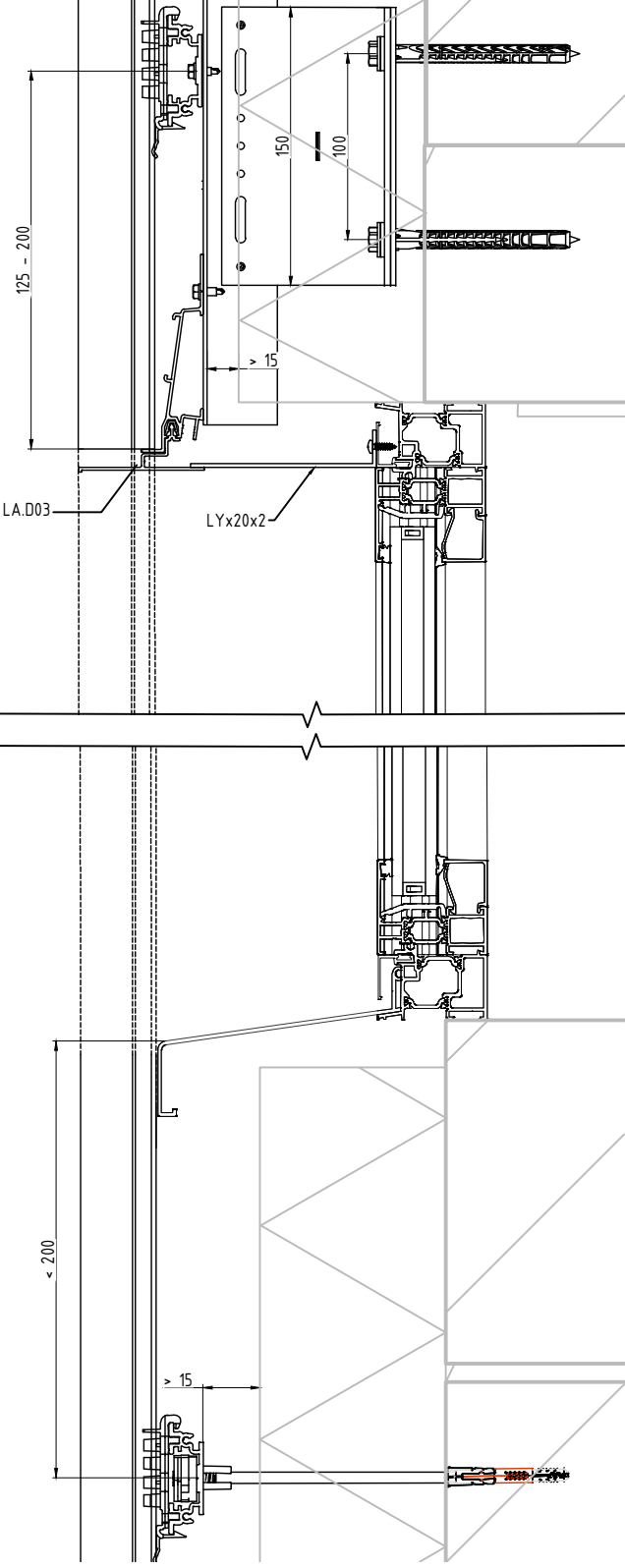

Deze tekening is eigendom van NV RENSON, en mag niet gecopieerd, noch getoond worden aan derden zonder schriftelijke toestemming.

**RENSON**  
Creating healthy spaces

Industriezone "Flanders field"  
8790 Waregem (Belgium)  
Tel. 056/62.71.11 Fax. 056/60.28.51

Drawn By	Date 11/05/2020	Scale 1:4
WINDOW TRIM TOPSIDE		Format A4
SIDE VIEW	8H	

1

2

3

4

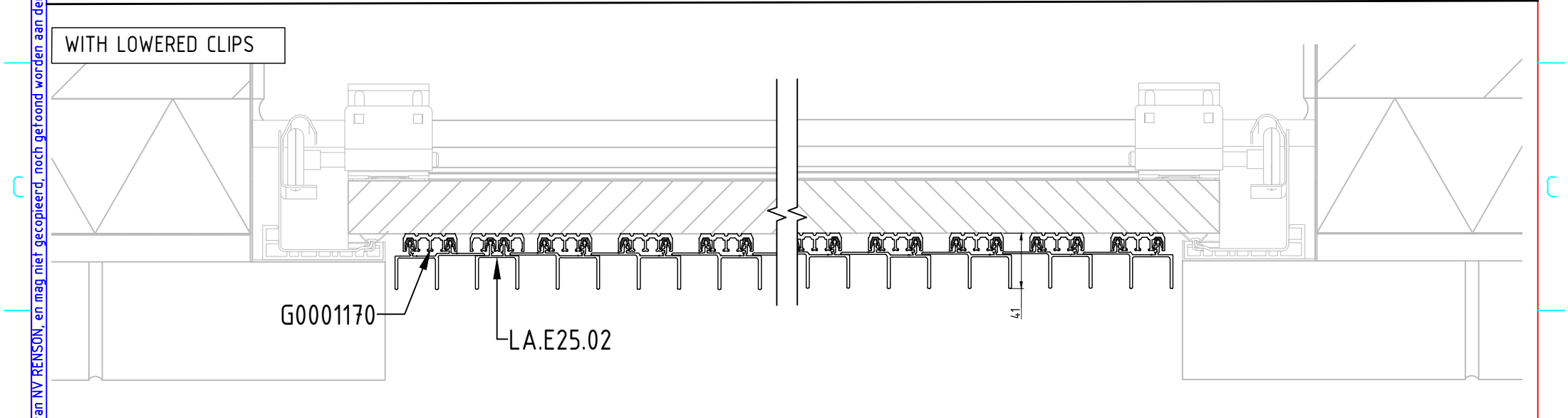
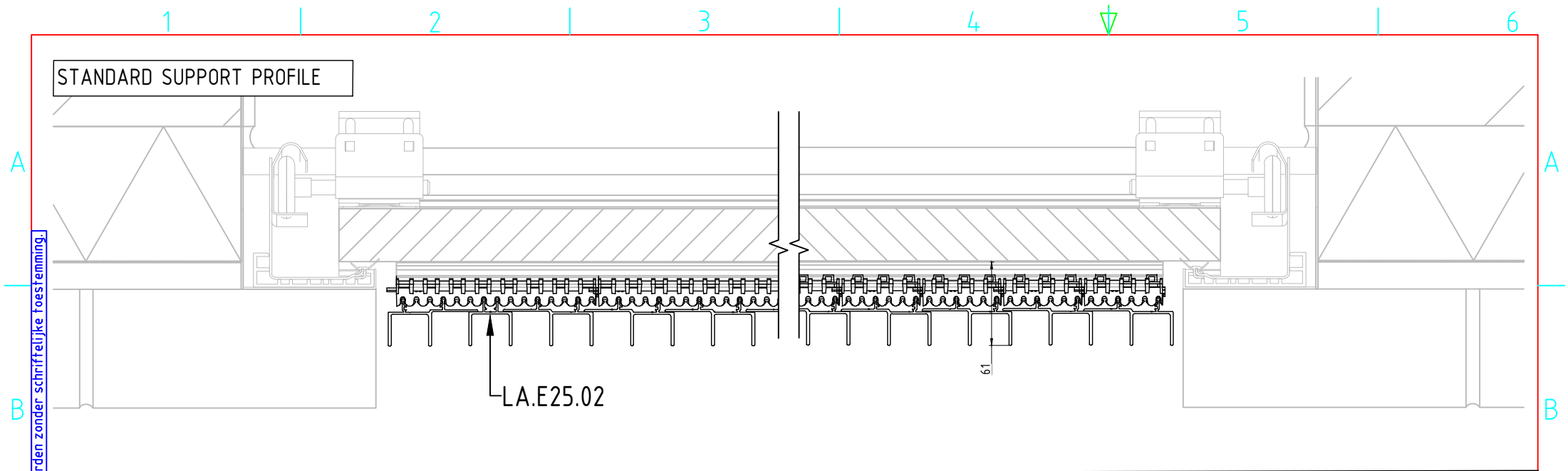

Deze tekening is eigendom van NV RENSON, en mag niet gecopieerd, noch getoond worden aan derden zonder schriftelijke toestemming.

 Industriezone "Flanders field" 8790 Waregem (Belgium) Tel. 056/62.71.11 Fax. 056/60.28.51	Drawn By	Date	Scale
	SECTIONAL GARAGE DOOR BETWEEN OTHER CLADDING		Format
	TOP VIEW		9A



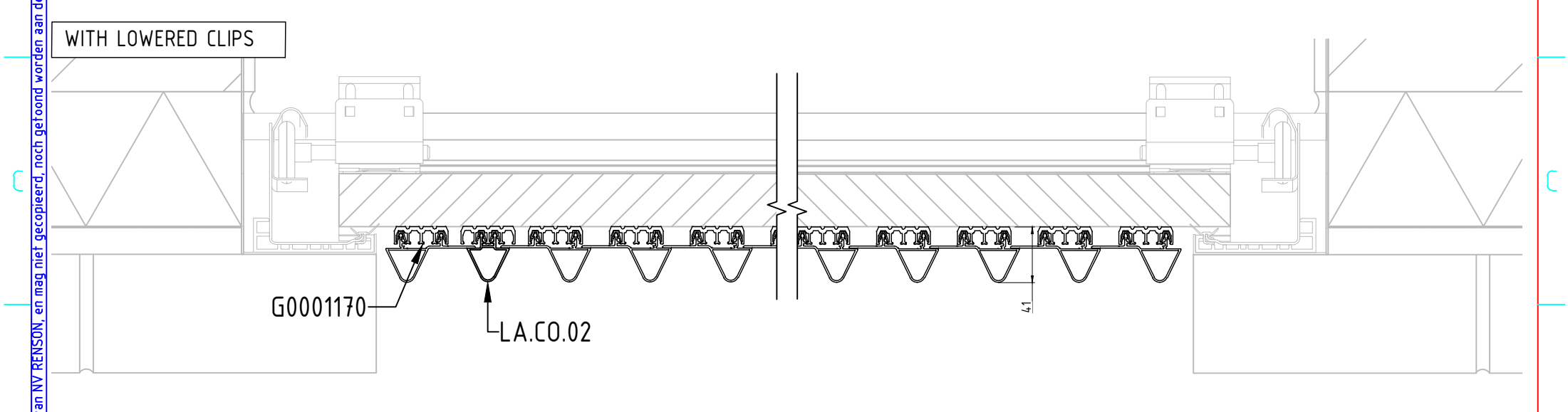
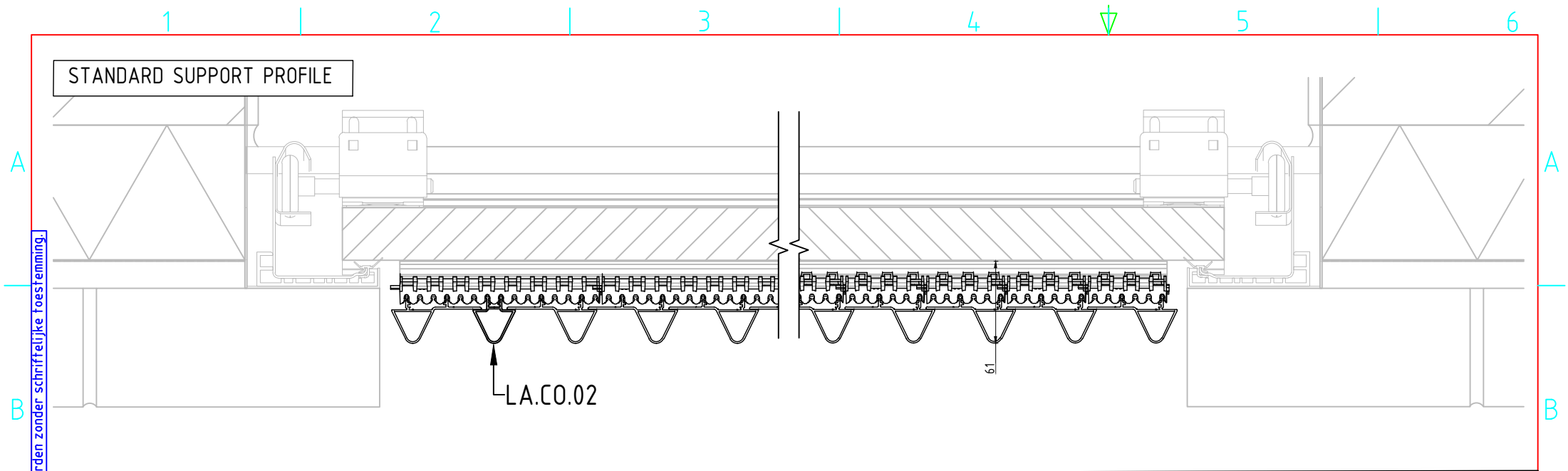

Deze tekening is eigendom van NV RENSON, en mag niet gecopieerd, noch getoond worden aan derden zonder schriftelijke toestemming.

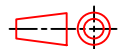
 Industriezone "Flanders field" 8790 Waregem (Belgium) Tel. 056/62.71.11 Fax. 056/60.28.51	Drawn By	Date	Scale	
	SECTIONAL GARAGE DOOR BETWEEN OTHER CLADDING		11/05/2020	1:4
	TOP VIEW		9B	Format A4 

1 | 2 | 3 | 4

WITH L-PROFILE

WITH SUPPORT PROFILE

A

A

B

B

C

C

D

D

E

E

F

F

Deze tekening is eigendom van NV RENSON, en mag niet gecopieerd, noch getoond worden aan derden zonder schriftelijke toestemming.

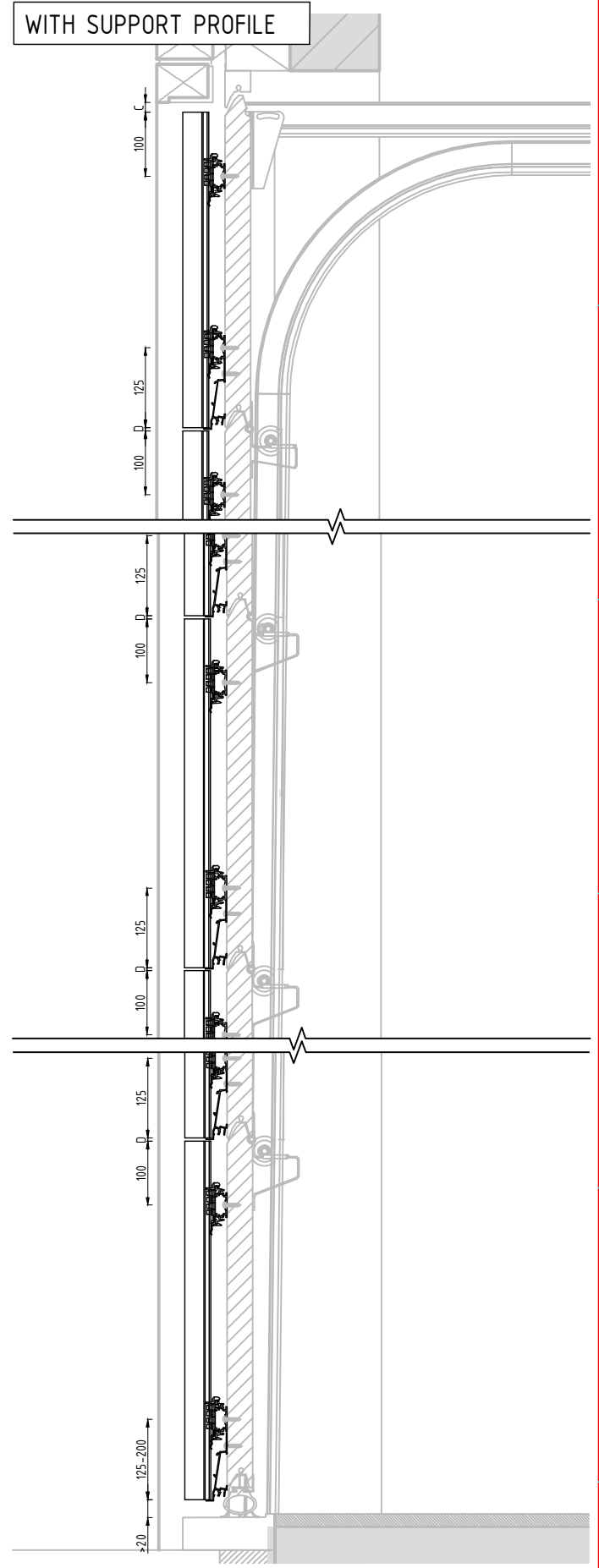
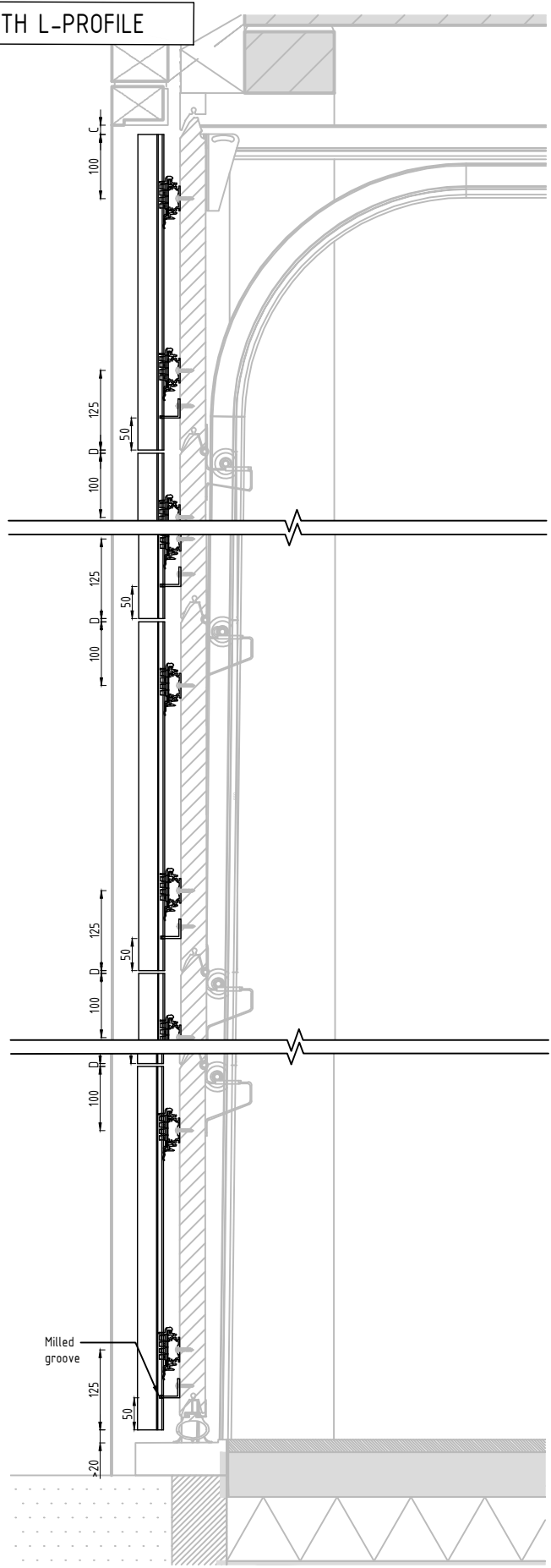

**RENSON**  
Creating healthy spaces

Industriezone "Flanders field"  
8790 Waregem (Belgium)  
Tel. 056/62.71.11 Fax. 056/60.28.51

Drawn By

Date  
11/05/2020

Scale  
1:10

SECTIONAL GARAGE  
DOOR BETWEEN OTHER CLADDING

Format  
A4

SIDE VIEW

9C

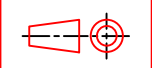

1 | 2 | 3 | 4

Deze tekening is eigendom van NV RENSON, en mag niet gecopieerd, noch getoond worden aan derden zonder schriftelijke toestemming.

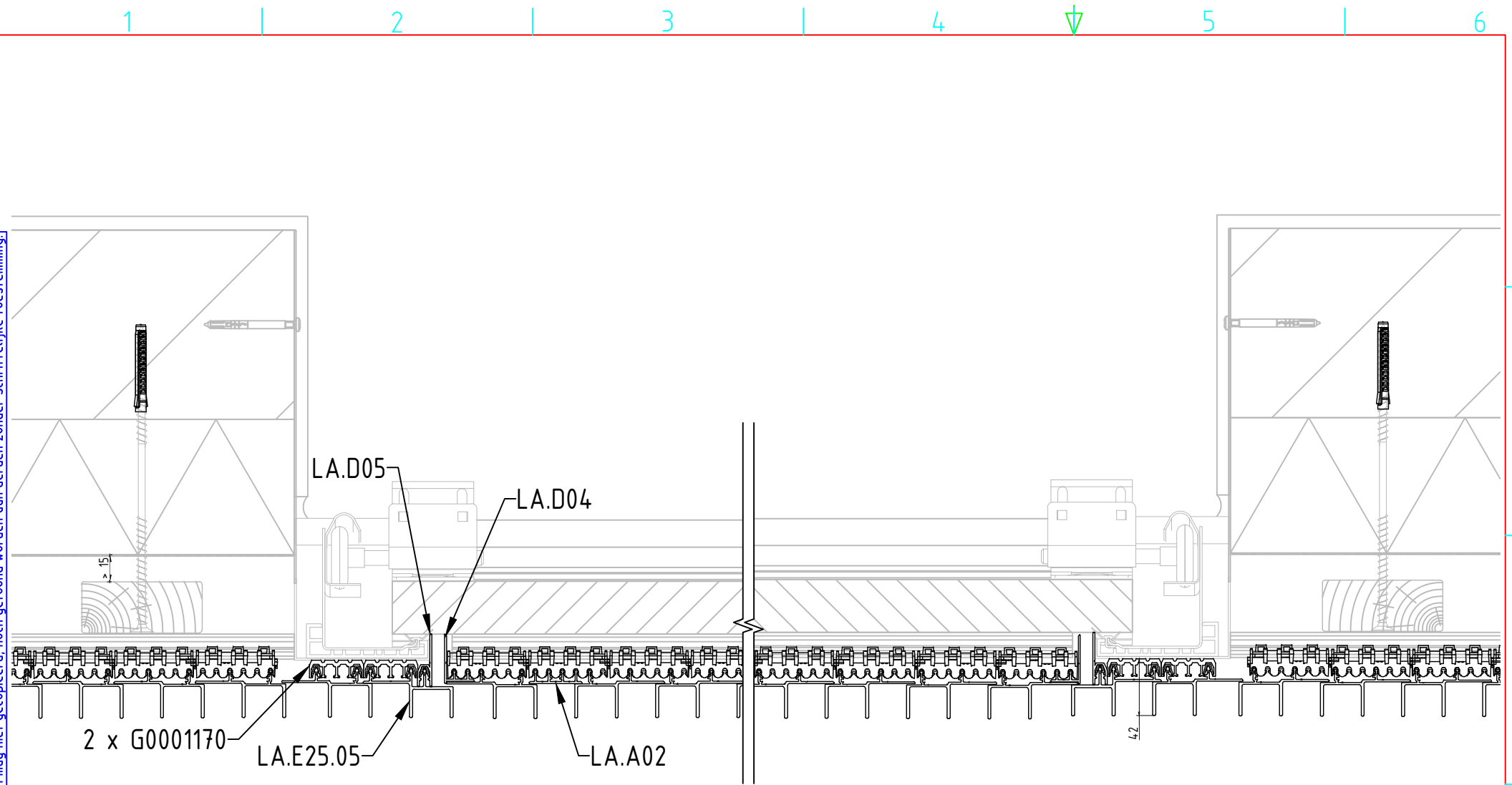

**RENSON**  
 Creating healthy spaces  
 Industriezone "Flanders field"  
 8790 Waregem (Belgium)  
 Tel. 056/62.71.11 Fax. 056/60.28.51

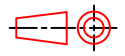
Drawn By	Date 11/05/2020	Scale 1:4
SECTIONAL GARAGE DOOR CONTINUOUS CLADDING		Format A4
TOP VIEW		10A 

1 | 2 | 3 | 4 | 5 | 6

Deze tekening is eigendom van NV RENSON, en mag niet gecopieerd, noch getoond worden aan derden zonder schriftelijke toestemming.

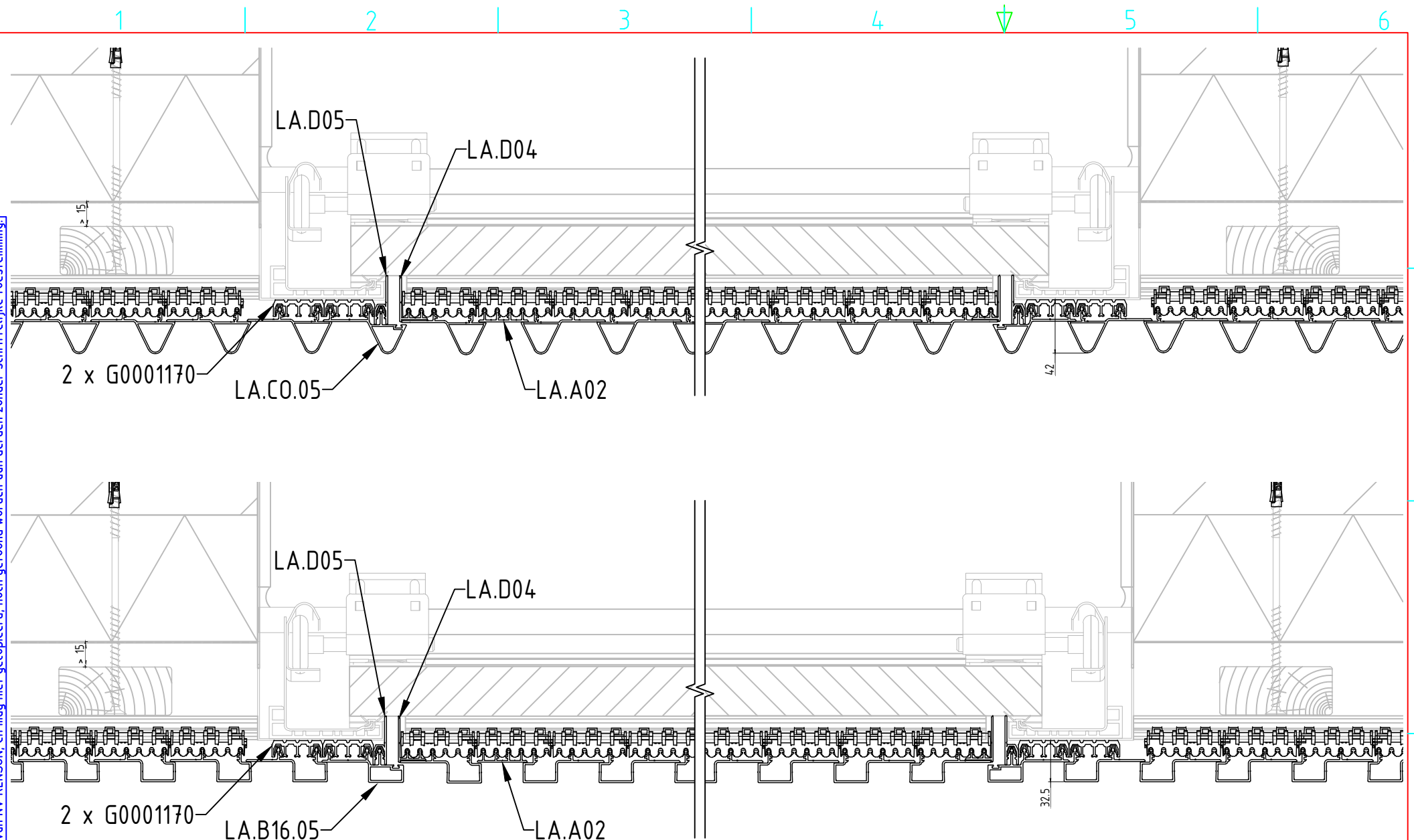

**RENSON**  
 Creating healthy spaces  
 Industriezone "Flanders field"  
 8790 Waregem (Belgium)  
 Tel. 056/62.71.11 Fax. 056/60.28.51

Drawn By	Date 11/05/2020	Scale 1:4
SECTIONAL GARAGE DOOR CONTINUOUS CLADDING		Format A4
TOP VIEW		10B

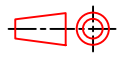

Deze tekening is eigendom van NV RENSON, en mag niet gecopieerd, noch gebruikt worden aan derden zonder schriftelijke toestemming.

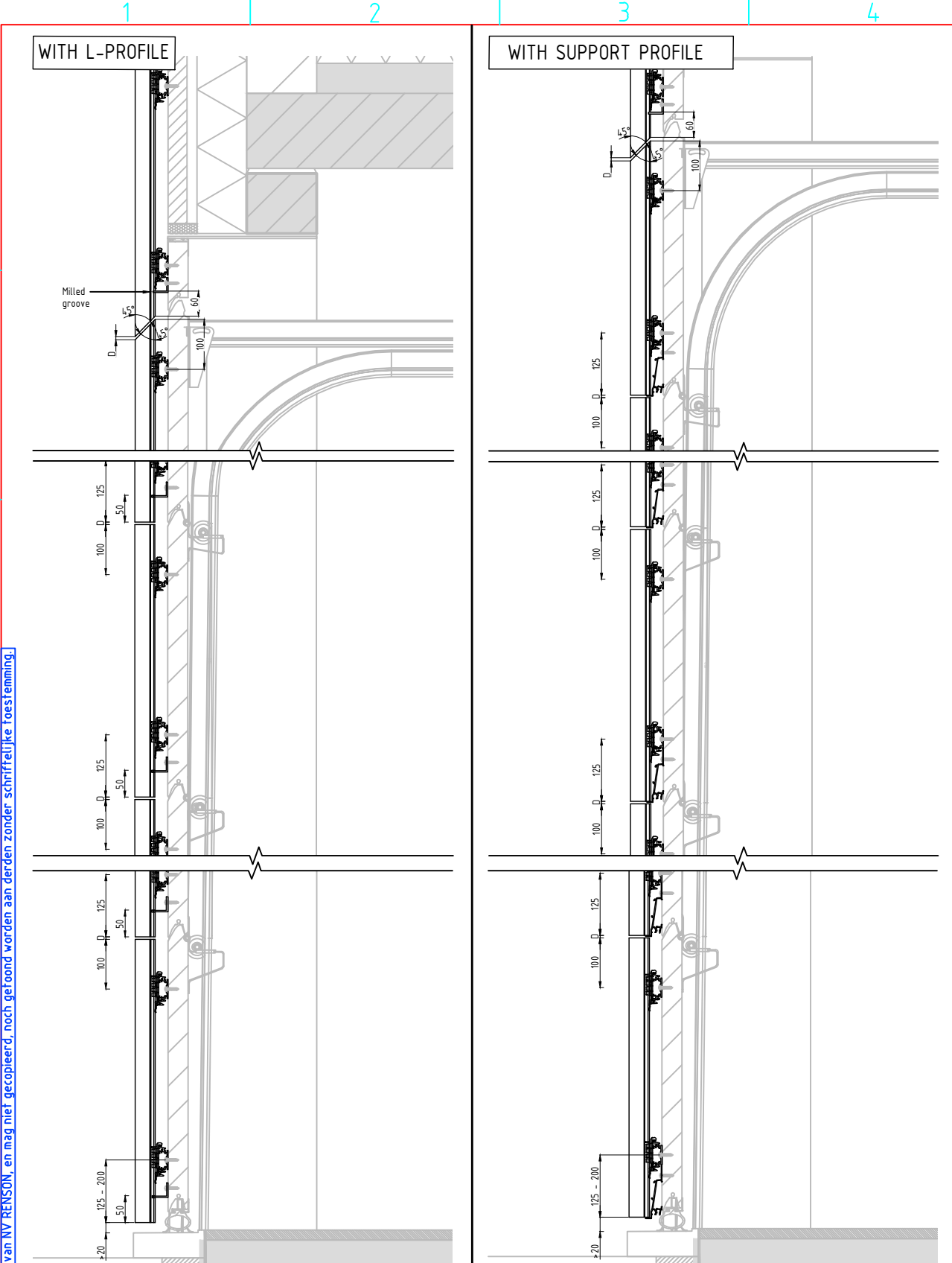

**RENSON**  
 Creating healthy spaces  
 Industriezone "Flanders field"  
 8790 Waregem (Belgium)  
 Tel. 056/62.71.11 Fax. 056/60.28.51

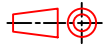
Drawn By	Date 11/05/2020	Scale 1:10
SECTIONAL GARAGE DOOR CONTINUOUS CLADDING		Format A4
SIDE VIEW		10C 

1 | 2 | 3 | 4

A | B | C | D | E | F